

LINIO NEON EOS TV

Indoor · Single Color · Field Cuttable



Features

- Hybrid neon tape, completely dot-free
- Field cuttable & joinable
- Slim and elegant looking, naturally blend into white walls
- UV stable without yellowing or cracking over time
- All dimming protocols dimmable
- 5 years warranty



Fixture type	
Project name	
Project phase	
Date	



Dimension & Bending

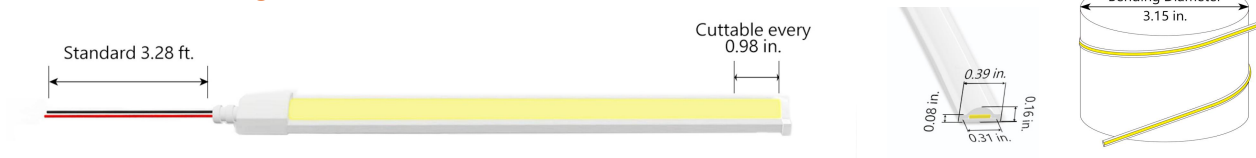

Physical

Dimensions	Width 0.39" (10mm)
Bend Direction	Vertical bending
Bend Diameter	3.15" (80mm)
Cutting Interval	0.98" (25mm)
Field Cuttable	Yes
Housing Material	Dow Corning
Housing Technique	Co-extrusion
Body Color	White
Finish	Matte
Feed Entry	Front
Feed Length	Standard length 3.28'
End Cap	Injected (Factory made only)/silicone
Mounting	Clips/extrusion/adhesive tape
Storage Temperature	-40~60°C (-40~140°F)
Ambient Temperature	-20~40°C (-4~104°F)
Max. Production Length	98.43ft (30m)

Performance & Electrical

Voltage	24VDC (23.5Vmin, 24.5Vmax)
Beam Angle	110°
MacAdam	3 steps
Efficacy (lm/W)	65.6lm/W @4000K
CRI	≥90
Lumen Maintenance	> 54,000 hours
IP Rating	IP65
Resistance	UV, solvent, saltwater, flame
Dimming	Triac, ELV, PWM, 0-10V, DMX
Control Protocol	N/A
Warranty	5 years

Certification & Safety

Certifications	UL
Environment	Dry or damp locations

Lumen/ft	1.46W	2.93W	4.39W
■ 2200K	84	168	252
■ 2700K	91	208	274
■ 3000K	95	217	284
■ 3500K	93	224	279
■ 4000K	96	237	288
■ 5700K	95	189	284
Max. Run Length (ft)	16.4	16.4	16.4

*Other color temperatures and single chromatic colors customizable.

LINIO NEON EOS TV

Indoor · Single Color · Field Cuttable



Order Code

Series	Temp./Color	Power	Feed Entry	Connector Wire	End Cap	Length (ft)
LNEOSTV	22=2200K 27=2700K 30=3000K 35=3500K 40=4000K 57=5700K	146=1.46W 293=2.93W 439=4.39W	FF=Front + Front FC=Front + Closed	OW=Open wire 3.28' MFC=Male & female connector 0.98'	IJ=Injected end cap (IP65) SEC=Silicone end cap (IP65) * End caps are added by default	Min. - 0.98" Max. - 98.4" Cut Inc. - 0.98"

Example: LNEOSTV-27-146-FF-OW-IJ-11'

* Customizable—Contact Beamever representatives

*This product is not rated as submersible. Do not install in a location where water may pool or collect.

Feed Entry Options

Front+Front feed entry (FF)

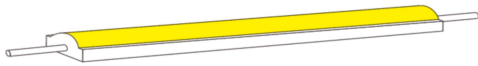

Front+Closed feed entry (FC)

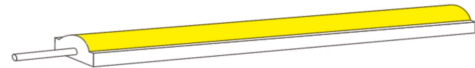

Mounting Options

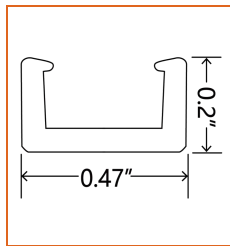

* Recommend use 1 mounting clip for 1' of neon.

Name	Mounting clip
Code	LNEOS-CL-10
Material	Silicone
Mounting style	Surface mounted
Length	0.55" (14mm)
Width	0.47" (12mm)
Height	0.2" (5mm)
Internal Width	/

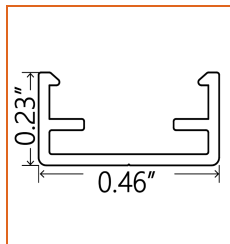

* Standard length is 3.28'/pcs.

Name	Straight aluminum channel
Code	LNEOS-SC-10
Material	Aluminum
Mounting style	Surface mounted
Length	3.28' (1m)
Width	0.46" (11.7mm)
Height	0.23" (5.8mm)
Internal width	/

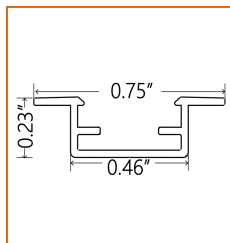

* Standard length is 3.28'/pcs.

Name	Recessed aluminum channel
Code	LNEOS-RC-10
Material	Aluminum
Mounting style	Recessed mounted
Length	3.28' (1m)
Width	0.75" (19mm)
Height	0.23" (5.8mm)
Internal width	/

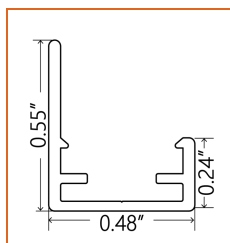

* Standard length is 3.28'/pcs.

Name	Light-block aluminum channel
Code	LNEOS-LBC-10
Material	Aluminum
Mounting style	Surface mounted
Length	3.28' (1m)
Width	0.48" (12.3mm)
Height	0.55" (14mm)
Internal width	/

LINIO NEON EOS TV

Indoor · Single Color · Field Cuttable

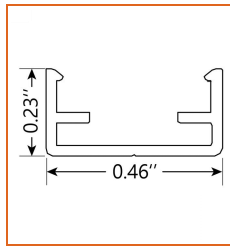
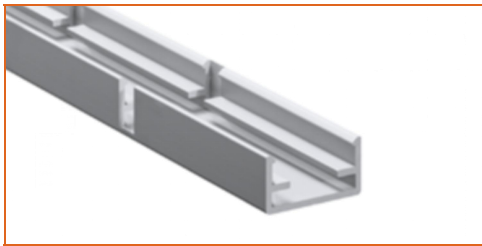

* Standard length is 1m/pcs.

Name	Bendable aluminum channel
Code	LNEOS-BC-10
Material	Aluminum
Mounting style	Surface mounted
Length	3.28' (1m)
Width	0.46" (11.7mm)
Height	0.23" (5.8mm)
Internal width	/

Driver Options

Code	Max Load	Input	Output	Dimmable	Class 2	Environment	Size (L*W*H)
Non Dimmable							
KV-24030-ASW	30W	100-277VAC	24V	No	Yes	Dry/damp	6.10*2.12*0.78 inch
KV-24060-ASW	60W	100-277VAC	24V	No	Yes	Dry/damp	7.00*2.40*0.94 inch
KV-24096-ASW	96W	100-277VAC	24V	No	Yes	Dry/damp/wet	9.05*2.75*1.69 inch
KV-24150-ASW	150W	100-277VAC	24V	No	No	Dry/damp/wet	10.07*3.07*1.85 inch
KV-24200-ASW	200W	100-277VAC	24V	No	No	Dry/damp/wet	10.07*3.07*1.85 inch
KV-24300-ASW	300W	100-277VAC	24V	No	No	Dry/damp/wet	10.86*3.07*1.85 inch
Phase cut /Triac Dimmable							
KVF-24030-TDW	30W	100-277VAC	24V	Yes	Yes	Dry/damp	6.10*2.12*0.78 inch
KVF-24060-TDW	60W	100-277VAC	24V	Yes	Yes	Dry/damp	7*2.4*0.94 inch
KVF-24096-TDW	96W	100-277VAC	24V	Yes	Yes	Dry/damp/wet	9.05*2.75*1.69 inch
KVF-24150-TDW	150W	100-277VAC	24V	Yes	No	Dry/damp/wet	10*3.07*1.85 inch
KVF-24200-TDW	200W	100-277VAC	24V	Yes	No	Dry/damp/wet	10*3.07*1.85 inch
KVF-24300-TDW	300W	100-277VAC	24V	Yes	No	Dry/damp/wet	10.87*3.07*1.85 inch
4 in 1 Dimmable (0-10V/1-10V/Potentiometer/10V PWM)							
KVD-24030-DIM	30W	100-277VAC	24V	Yes	Yes	Dry/damp	6.10*2.12*0.78 inch
KVD-24060-DIM	60W	100-277VAC	24V	Yes	Yes	Dry/damp	7.01*2.40*0.94 inch
KVD-24096-DIM	96W	100-277VAC	24V	Yes	Yes	Dry/damp/wet	9.05*2.75*1.69 inch
KVD-24150-DIM	150W	100-277VAC	24V	Yes	No	Dry/damp/wet	10.08*3.07*1.85 inch
KVD-24200-DIM	200W	100-277VAC	24V	Yes	No	Dry/damp/wet	13.38*11.02*7.28 inch
KVD-24300-DIM	300W	100-277VAC	24V	Yes	No	Dry/damp/wet	10.87*3.07*1.89 inch
5 in 1 Dimmable (Triac/0-10V/1-10V/Potentiometer/10V PWM)							
KVG-24030-DW	30W	100-277VAC	24V	Yes	Yes	Dry/damp	6.1*2.13*0.79 inch
KVG-24060-DW	60W	100-277VAC	24V	Yes	Yes	Dry/damp	7.01*2.41*0.94 inch
KVG-24096-DW	96W	100-277VAC	24V	Yes	Yes	Dry/damp/wet	9.06*2.76*1.69 inch
KVG-24150-DW	150W	100-277VAC	24V	Yes	No	Dry/damp/wet	10.08*3.07*1.85 inch
KVG-24200-DW	200W	100-277VAC	24V	Yes	No	Dry/damp/wet	10.08*3.07*1.85 inch
KVG-24300-DW	300W	100-277VAC	24V	Yes	No	Dry/damp/wet	10.87*3.07*1.89 inch

* Please refer to the spec sheet of each power supply for more detailed information

* KVF, KVD, KVG series are available in junction box enclosure, you can select it by adding "J" at the end of the driver code, e.g. KVF-24030-TDWJ, and refer to its standalone spec sheet on our website.

LINIO NEON EOS TV

Indoor · Single Color · Field Cuttable



Accessories Options (Optional, purchase for extra)



Name Silicone closed end cap
Code LNEOS-SEC-C-10
Closed silicone end cap for 0.39" wide LINIO NEON EOS TV



Name Silicone front end cap
Code LNEOS-SEC-F-2P-10
Silicone end cap front entry with 7.87" 2 pin cable

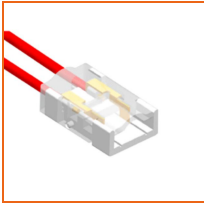

Name Strip to cable connector
Code LNEOS-STC-2P-10
Strip-to-cable connector with 5.91" cable, IP20, 2 pin

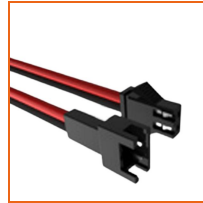

Name Male and female connectors
Code MFC-2P-20
Male and female connectors with 11.81" cable, IP20, 2 pin



Name Silicone glue
Code SG
Silicone glue



Name VHB 3M adhesive back tape
Code VHB
EOS already comes with normal 3M back tape, VHB 3M tape has stronger stickiness.

Wiring Diagram

Non Dimmable

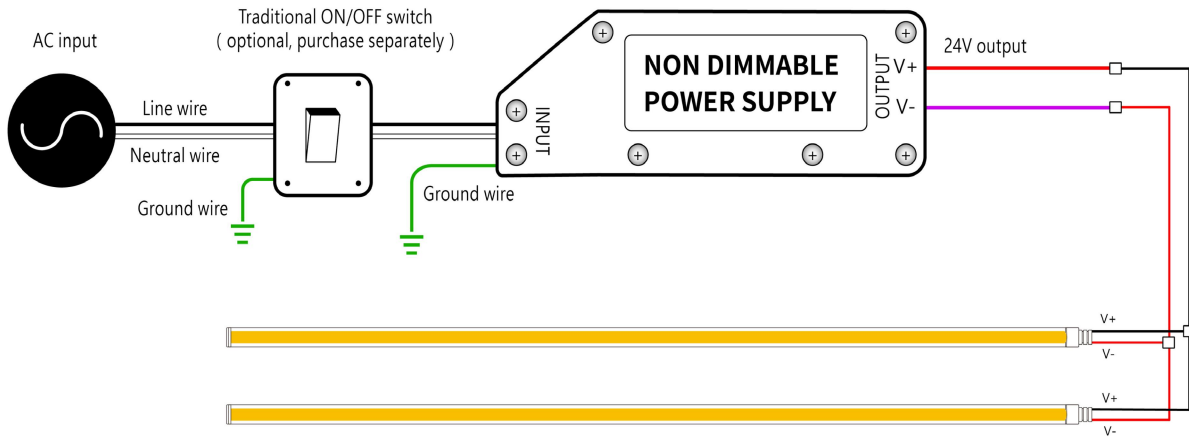

Dimmable

