

# LINIO NEON 1615 TV

Outdoor · Vertical Bending · Field Cuttable



## Features

- Field cuttable & joinable
- Low voltage 24V DC
- All dimming protocols dimmable
- Max run length up to 89ft from single power feed
- IP67 rated, ideal for indoor and outdoor use
- UV stable without yellowing or cracking over time



Fixture type	
Project name	
Project phase	
Date	



## Dimension & Bending

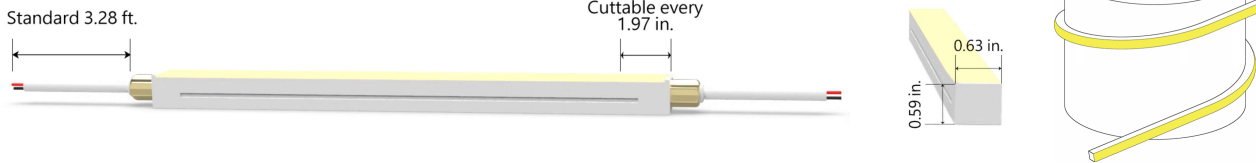

## Physical

Dimensions	0.63" x 0.59" (width x height)
Bend Direction	Vertical bending
Bend Diameter	9.45" (240mm)
Cutting Interval	1.97" (50mm)
Field Cuttable	Yes
Housing Material	Dow Corning
Housing Technique	Co-extrusion
Body Color	White
Finish	Matte
Feed Entry	Front, side, bottom
Feed Length	Standard length 3.28'
End Cap	Injected/silicone/mechanical
Mounting	Clips or channels (rigid or bendable)
Storage Temperature	-25°C~60°C (-13°F~140°F)
Ambient Temperature	Ta <sub>min</sub> = -25°C/-13°F, Ta <sub>max</sub> (See below)
Max. Production Length	98.43ft (30m)

## Performance & Electrical

Voltage	24VDC (23.5Vmin, 24.5Vmax)
Beam Angle	120°
MacAdam	2 steps
Efficacy (lm/W)	50.5lm/W @4000K 3.05W
CRI	>90
Lumen Maintenance	> 54,000 hours
IP Rating	IP67
Resistance	UV, solvent, saltwater, flame
Dimming	Triac, ELV, PWM, 0-10V, DMX, SPI
Control Protocol	N/A
Warranty	5 years

## Certification & Safety

Certifications	UL
Environment	Dry, damp or wet locations

Lumen/ft	1.52W	3.05W	4.57W
■ 2700K	70	139	193
■ 3000K	72	143	197
■ 3500K	73	142	201
■ 4000K	74	146	205
Max. Run Length (ft)	88.6	55.8	45.9
Max. Run for Mechanical End Cap (ft)	65.6	32.8	21.65
Ambient Temperature (Ta <sub>max</sub> )	55°C/131°F	45°C/113°F	35°C/95°F

# LINIO NEON 1615 TV

Outdoor · Vertical Bending · Field Cuttable



## Order Code

Series	Temp./Color	Power	Feed Entry	Connector Wire	End Cap	Length (ft)
LN1615TV	27=2700K 30=3000K 35=3500K 40=4000K	152=1.52W 305=3.05W 457=4.57W	FF=Front + Front BB=Bottom + Bottom SS=Side + Side FC=Front + Closed FB=Front + Bottom BF=Bottom+Front FLS=Front + Left Side FRS=Front + Right Side BC=Bottom + Closed BLS=Bottom + Left Side BRS=Bottom + Right Side LSC=Left Side + Closed RSC=Right Side + Closed	OW=Open wire 3.28' MFCW=Male & female connector with 0.98' white cable MFCB=Male & female connector with 0.98' black cable	IJ=Injected end cap (IP67) * Factory made only SEC=Silicone end cap (IP67) MEC=Mechanical end cap (IP67) * End caps are added by default	Min. - 1.97" Max. - 98.4' Cut Inc. - 1.97"

Example: LN1615TV-30-305-FF-OW-IJ-11'

\* Customizable—Contact Beamever representatives

\*This product is not rated as submersible. Do not install in a location where water may pool or collect.

## Feed Entry Options

Front+Front feed entry (FF)

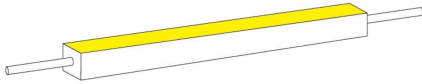

Bottom+Bottom feed entry (BB)

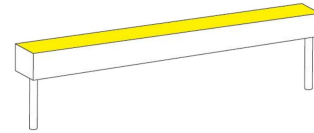

Side+Side feed entry (SS)

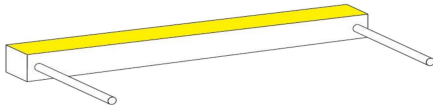

Front+Closed feed entry (FC)

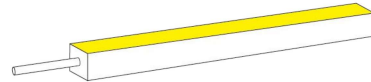

Front+Bottom feed entry (FB)

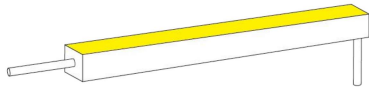

Bottom+Front feed entry (BF)

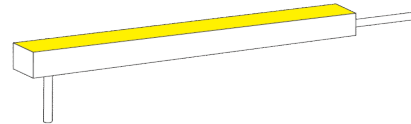

Front+Left Side feed entry (FLS)

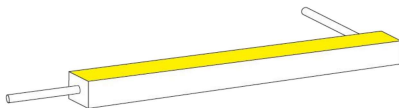

Front+Right Side feed entry (FRS)

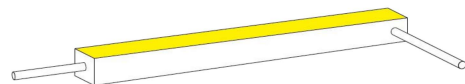

Bottom+Closed feed entry (BC)

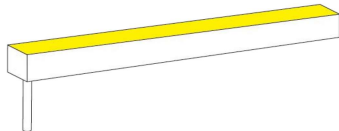

Bottom+Left Side feed entry (BLS)

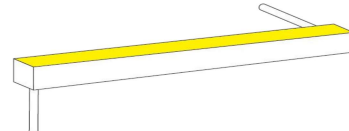

Bottom+Right Side feed entry (BRS)

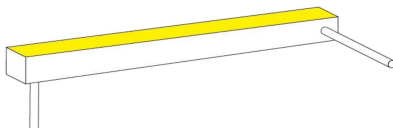

Left Side+Closed feed entry (LSC)

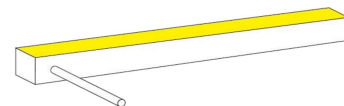

Right Side+Closed feed entry (RSC)

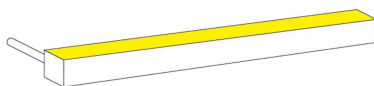

# LINIO NEON 1615 TV

Outdoor · Vertical Bending · Field Cuttable



## Mounting Options

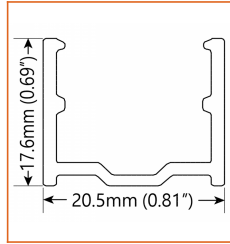
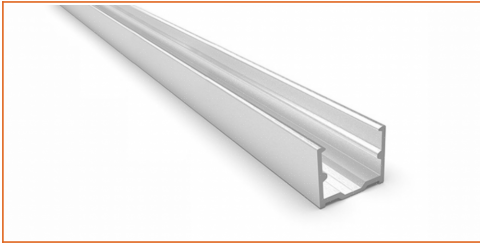

\* Standard length is 3.28' / pcs.

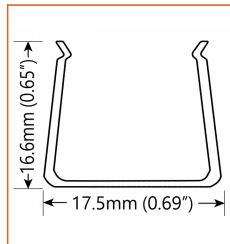
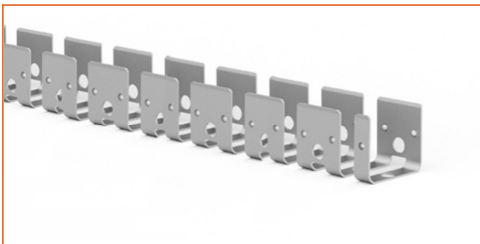

\* Standard length is 1.64' / pcs.

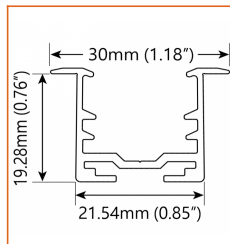
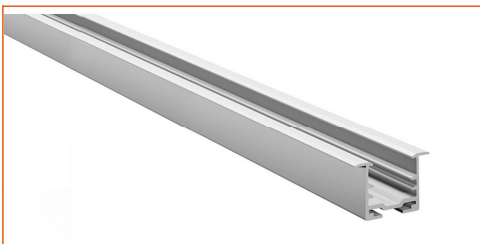

\* Standard length is 3.28' / pcs.

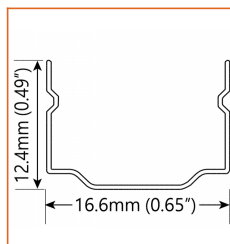

\* Recommend use 1 mounting clip for 1' of neon.

Name	Straight aluminum channel
Code	LN1615-SC
Material	Aluminum
Mounting style	Surface mounted
Length	3.28' (1m)
Width	0.81" (20.5mm)
Height	0.69" (17.6mm)
Internal width	/

Name	Bendable channel
Code	LN1615-BC
Material	Stainless Steel
Mounting style	Surface mounted
Length	1.64' (0.5m)
Width	0.69" (17.5mm)
Height	0.65" (16.6mm)
Internal Width	/

Name	Recessed straight channel
Code	LN1615-RSC
Material	Aluminum
Mounting style	Recessed mounted
Length	3.28' (1m)
Width	1.18" (30mm)
Height	0.76" (19.28)
Internal width	/

Name	Mounting clip
Code	LN1615-CL
Material	Stainless Steel
Mounting style	Surface mounted
Length	0.79" (20mm)
Width	0.65" (16.6mm)
Height	0.49" (12.4mm)
Internal Width	/

# LINIO NEON 1615 TV

Outdoor · Vertical Bending · Field Cuttable



## Driver Options

Code	Max Load	Input	Output	Dimmable	Class 2	Environment	Size (L*W*H)
<b>Non Dimmable</b>							
KV-24030-ASW	30W	100-277VAC	24V	No	Yes	Dry/damp	6.10*2.12*0.78 inch
KV-24060-ASW	60W	100-277VAC	24V	No	Yes	Dry/damp	7.00*2.40*0.94 inch
KV-24096-ASW	96W	100-277VAC	24V	No	Yes	Dry/damp/wet	9.05*2.75*1.69 inch
KV-24150-ASW	150W	100-277VAC	24V	No	No	Dry/damp/wet	10.07*3.07*1.85 inch
KV-24200-ASW	200W	100-277VAC	24V	No	No	Dry/damp/wet	10.07*3.07*1.85 inch
KV-24300-ASW	300W	100-277VAC	24V	No	No	Dry/damp/wet	10.86*3.07*1.85 inch
<b>Phase cut /Triac Dimmable</b>							
KVF-24030-TDW	30W	100-277VAC	24V	Yes	Yes	Dry/damp	6.10*2.12*0.78 inch
KVF-24060-TDW	60W	100-277VAC	24V	Yes	Yes	Dry/damp	7*2.4*0.94 inch
KVF-24096-TDW	96W	100-277VAC	24V	Yes	Yes	Dry/damp/wet	9.05*2.75*1.69 inch
KVF-24150-TDW	150W	100-277VAC	24V	Yes	No	Dry/damp/wet	10*3.07*1.85 inch
KVF-24200-TDW	200W	100-277VAC	24V	Yes	No	Dry/damp/wet	10*3.07*1.85 inch
KVF-24300-TDW	300W	100-277VAC	24V	Yes	No	Dry/damp/wet	10.87*3.07*1.85 inch
<b>4 in 1 Dimmable (0-10V/1-10V/Potentiometer/10V PWM)</b>							
KVD-24030-DIM	30W	100-277VAC	24V	Yes	Yes	Dry/damp	6.10*2.12*0.78 inch
KVD-24060-DIM	60W	100-277VAC	24V	Yes	Yes	Dry/damp	7.01*2.40*0.94 inch
KVD-24096-DIM	96W	100-277VAC	24V	Yes	Yes	Dry/damp/wet	9.05*2.75*1.69 inch
KVD-24150-DIM	150W	100-277VAC	24V	Yes	No	Dry/damp/wet	10.08*3.07*1.85 inch
KVD-24200-DIM	200W	100-277VAC	24V	Yes	No	Dry/damp/wet	13.38*11.02*7.28 inch
KVD-24300-DIM	300W	100-277VAC	24V	Yes	No	Dry/damp/wet	10.87*3.07*1.89 inch
<b>5 in 1 Dimmable (Triac/0-10V/1-10V/Potentiometer/10V PWM)</b>							
KVG-24030-DW	30W	100-277VAC	24V	Yes	Yes	Dry/damp	6.1*2.13*0.79 inch
KVG-24060-DW	60W	100-277VAC	24V	Yes	Yes	Dry/damp	7.01*2.41*0.94 inch
KVG-24096-DW	96W	100-277VAC	24V	Yes	Yes	Dry/damp/wet	9.06*2.76*1.69 inch
KVG-24150-DW	150W	100-277VAC	24V	Yes	No	Dry/damp/wet	10.08*3.07*1.85 inch
KVG-24200-DW	200W	100-277VAC	24V	Yes	No	Dry/damp/wet	10.08*3.07*1.85 inch
KVG-24300-DW	300W	100-277VAC	24V	Yes	No	Dry/damp/wet	10.87*3.07*1.89 inch

\* Please refer to the spec sheet of each power supply for more detailed information

\* KVF, KVD, KVG series are available in junction box enclosure, you can select it by adding "J" at the end of the driver code, e.g. KVF-24030-TDWJ, and refer to its standalone spec sheet on our website.

## Accessories Options (Optional, purchase for extra)



Name Silicone closed end cap

Code LN1615-SEC-C

Closed silicone end cap

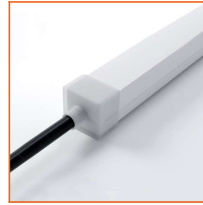

Name Silicone front end cap

Code LN1615-SEC-F-2P

Silicone end cap front entry with 11.81" black cable, 2 pin



Name Silicone side end cap

Code LN1615-SEC-S-2P

Silicone end cap side entry with 11.81" black cable, 2 pin



Name Silicone bottom end cap

Code LN1615-SEC-B-2P

Silicone end cap bottom entry with 11.81" black cable, 2 pin



Name Mechanical end cap

Code LN1615-MEC-C

Mechanical closed end cap with screws

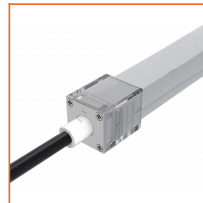

Name Mechanical end cap

Code LN1615-MEC-F-2P

Mechanical end cap with screws, front entry with 11.81" black cable, 2 pin



Name Mechanical end cap

Code LN1615-MEC-LS-2P

Mechanical end cap with screws, left side entry with 11.81" black cable, 2 pin



Name Mechanical end cap

Code LN1615-MEC-RS-2P

Mechanical end cap with screws, right side entry with 11.81" black cable, 2 pin



Name Mechanical end cap

Code LN1615-MEC-B-2P

Mechanical end cap with screws, bottom entry with 11.81" black cable, 2 pin



Name Male and female connectors

Code MFC-2P-67-W

Male and female connectors with 11.81" white cable, 2 pin



Name Male and female connectors

Code MFC-2P-67-B

Male and female connectors with 11.81" black cable, 2 pin



Name Extension connectors

Code ETC-2P-67-1M

Extension Male and female connectors with 1m(3.28ft) white cable, 2 pin



Name Extension connectors

Code ETC-2P-67-5M

Extension Male and female connectors with 5m(16.4ft) white cable, 2 pin

# LINIO NEON 1615 TV

Outdoor · Vertical Bending · Field Cuttable



## Wiring Diagram

### Non Dimmable

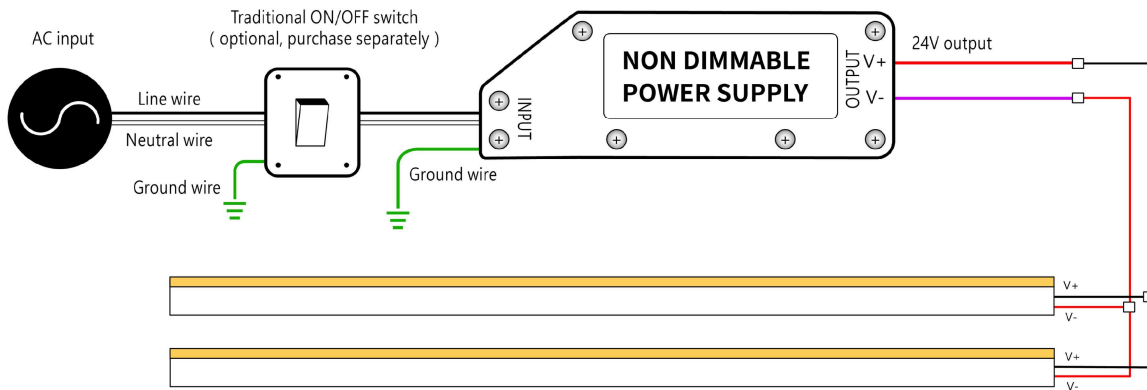

### Dimmable

