

AERO TAPE

Indoor · White

Beamever

Features

- Field cuttable & joinable
- Operates at safe and energy-efficient voltage of DC24V
- Slim and elegant, ideal for indoor applications
- 3M tape on the back makes it easy to install
- Available in a variety of CCT color options
- 5 years warranty



Fixture type	
Project name	
Project phase	
Date	



Dimension & Bending

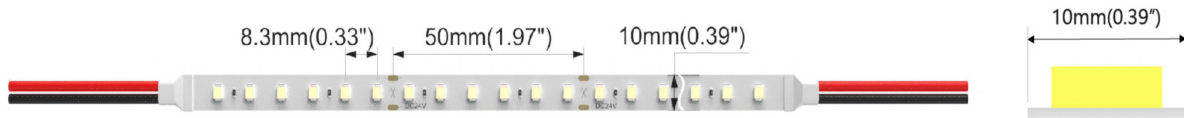

Physical

PCB Width	0.39" (10mm)
LED Pitch	0.33" (8.3mm)
Cutting Interval	1.97" (50mm)
LED Brand	Sanan
LED Size	2835
LED Quantity	36 LEDs/ft (120 LEDs/m)
Housing Material	N/A
Housing Technique	N/A
Adhesive Type	Yellow 3M tape
Feed Entry	Front
Feed Length	Standard length 3.28'
Storage Temperature	-25~60°C (-13~140°F)
Ambient Temperature	-20~45°C (-4~113°F)
Max Production Length	164ft (50m)

Performance & Electrical

Voltage	24VDC (23.5Vmin, 24.5Vmax)
Beam Angle	120°
MacAdam	3 steps
Efficacy (lm/W)	100lm/W @4000K
CRI	Ra90
Lumen Maintenance	> 54,000 hours
IP Rating	IP20
Resistance	UV, solvent, saltwater, flame
Dimming	Triac, ELV, PWM, 0-10V, DMX
Control Protocol	N/A
Warranty	5 years

Certification & Safety

Certifications	UL
Environment	Dry location

Lumen/ft	1.46W	2.93W	4.39W	5.85W	7.32W
■ 2700K	137	218	402	566	671
■ 3000K	142	223	422	579	698
■ 4000K	147	243	442	601	726
■ 6500K	155	296	444	605	716
Max. Run Length (ft)	16.4	16.4	16.4	16.4	16.4

*Other color temperatures and single chromatic colors customizable.

AERO TAPE

Indoor · White



Order Code

Series	Temp./Color	Power	Connector Wire	IP Rating	Length (ft)
AERO	27=2700K 30=3000K 40=4000K 65=6500K	146=1.46W 293=2.93W 439=4.39W 585=5.85W 732=7.32W	OW=Open wire 3.28' MFC=Male & female connector 0.98'	20=IP20	Min. - 1.97" Max. - 98.4' Cut Inc. - 1.97"

Example: AERO-30-293-OW-20-11'

* Customizable—Contact Beamever representatives

Mounting Options

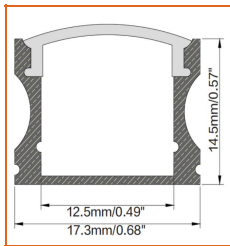
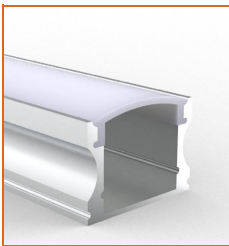

* Standard length is 3.28'/pcs.

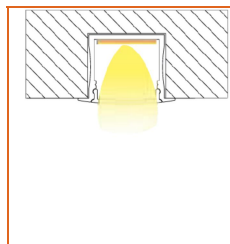
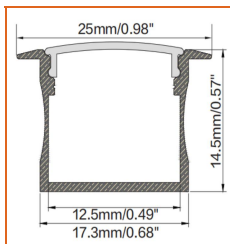
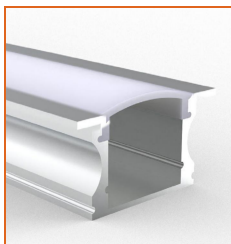

* Standard length is 3.28'/pcs.

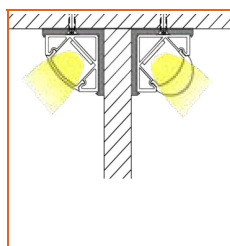
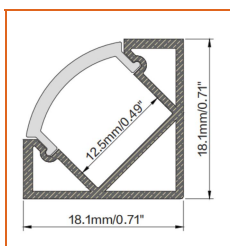
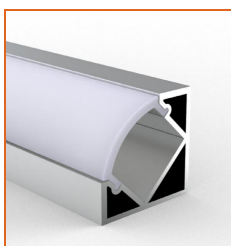

* Standard length is 3.28'/pcs.

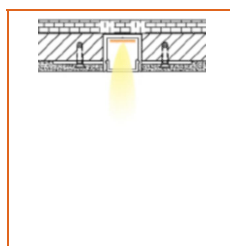
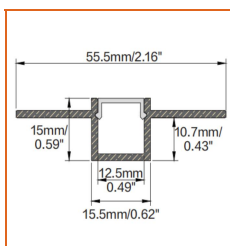
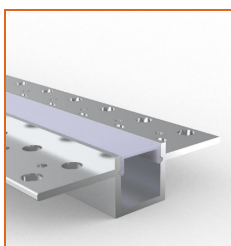

* Standard length is 3.28'/pcs.

* For more options, please refer to "Beamever Profile Spec Sheet"

Name	Straight aluminum channel
Code	BE1202
Material	Alluminum
Mounting style	Surface mounted
Length	3.28' (1m)
Width	0.68" (17.3mm)
Height	0.57" (14.5mm)
Internal width	0.49" (12.5mm)

Name	Straight aluminum channel
Code	BE1201
Material	Alluminum
Mounting style	Recessed mounted
Length	3.28' (1m)
Width	0.68" (17.3mm)
Height	0.57" (14.5mm)
Internal width	0.49" (12.5mm)

Name	Straight aluminum channel
Code	BE1203
Material	Alluminum
Mounting style	Angled mounted
Length	3.28' (1m)
Width	0.71" (18.1mm)
Height	0.71" (18.1mm)
Internal width	0.49" (12.5mm)

Name	Straight aluminum channel
Code	BE5615
Material	Alluminum
Mounting style	Mud-in
Length	3.28' (1m)
Width	0.62" (15.5mm)
Height	0.59" (15mm)
Internal width	0.49" (12.5mm)

AERO TAPE

Indoor · White



Driver Options

Code	Max Load	Input	Output	Dimmable	Class 2	Environment	Size (L*W*H)
Non Dimmable							
KV-24030-ASW	30W	100-277VAC	24V	No	Yes	Dry/damp	6.10*2.12*0.78 inch
KV-24060-ASW	60W	100-277VAC	24V	No	Yes	Dry/damp	7.00*2.40*0.94 inch
KV-24096-ASW	96W	100-277VAC	24V	No	Yes	Dry/damp/wet	9.05*2.75*1.69 inch
KV-24150-ASW	150W	100-277VAC	24V	No	No	Dry/damp/wet	10.07*3.07*1.85 inch
KV-24200-ASW	200W	100-277VAC	24V	No	No	Dry/damp/wet	10.07*3.07*1.85 inch
KV-24300-ASW	300W	100-277VAC	24V	No	No	Dry/damp/wet	10.86*3.07*1.85 inch
Phase cut /Triac Dimmable							
KVF-24030-TDW	30W	100-277VAC	24V	Yes	Yes	Dry/damp	6.10*2.12*0.78 inch
KVF-24060-TDW	60W	100-277VAC	24V	Yes	Yes	Dry/damp	7*2.4*0.94 inch
KVF-24096-TDW	96W	100-277VAC	24V	Yes	Yes	Dry/damp/wet	9.05*2.75*1.69 inch
KVF-24150-TDW	150W	100-277VAC	24V	Yes	No	Dry/damp/wet	10*3.07*1.85 inch
KVF-24200-TDW	200W	100-277VAC	24V	Yes	No	Dry/damp/wet	10*3.07*1.85 inch
KVF-24300-TDW	300W	100-277VAC	24V	Yes	No	Dry/damp/wet	10.87*3.07*1.85 inch
4 in 1 Dimmable (0-10V/1-10V/Potentiometer/10V PWM)							
KVD-24030-DIM	30W	100-277VAC	24V	Yes	Yes	Dry/damp	6.10*2.12*0.78 inch
KVD-24060-DIM	60W	100-277VAC	24V	Yes	Yes	Dry/damp	7.01*2.40*0.94 inch
KVD-24096-DIM	96W	100-277VAC	24V	Yes	Yes	Dry/damp/wet	9.05*2.75*1.69 inch
KVD-24150-DIM	150W	100-277VAC	24V	Yes	No	Dry/damp/wet	10.08*3.07*1.85 inch
KVD-24200-DIM	200W	100-277VAC	24V	Yes	No	Dry/damp/wet	13.38*11.02*7.28 inch
KVD-24300-DIM	300W	100-277VAC	24V	Yes	No	Dry/damp/wet	10.87*3.07*1.89 inch
5 in 1 Dimmable (Triac/0-10V/1-10V/Potentiometer/10V PWM)							
KVG-24030-DW	30W	100-277VAC	24V	Yes	Yes	Dry/damp	6.1*2.13*0.79 inch
KVG-24060-DW	60W	100-277VAC	24V	Yes	Yes	Dry/damp	7.01*2.41*0.94 inch
KVG-24096-DW	96W	100-277VAC	24V	Yes	Yes	Dry/damp/wet	9.06*2.76*1.69 inch
KVG-24150-DW	150W	100-277VAC	24V	Yes	No	Dry/damp/wet	10.08*3.07*1.85 inch
KVG-24200-DW	200W	100-277VAC	24V	Yes	No	Dry/damp/wet	10.08*3.07*1.85 inch
KVG-24300-DW	300W	100-277VAC	24V	Yes	No	Dry/damp/wet	10.87*3.07*1.89 inch

* Please refer to the spec sheet of each power supply for more detailed information

* KVF, KVD, KVG series are available in junction box enclosure, you can select it by adding "J" at the end of the driver code, e.g. KVF-24030-TDWJ, and refer to its standalone spec sheet on our website.

AERO TAPE

Indoor · White



Accessories Options (Optional)



Name Strip to strip connector

Code AERO20-STC-2P-10

Strip to strip connector, 2 pin, IP20



Name Strip to strip jumper connector

Code AERO20-STCJ-2P-10

Strip to strip jumper connector with 5.91" cable, 2 pin, IP20



Name Strip to cable connector

Code AERO20-STC-2P-10

Strip to cable connector with 5.91" cable, 2 pin, IP20



Name L-shaped connector

Code AERO20-L-2P-10

L-shaped connector, 2 pin, IP20



Name Male & female connector

Code MFC-2P-20

Male and female connector with 11.81" cable, IP20, 2 pin



Name Male & female DC connector

Code MFC-DC-44

Male and female DC connector with 11.81" cable, IP44

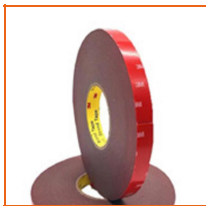

Name VHB 3M adhesive tape

Code VHB

VHB 3M adhesive back tape, stronger stickiness.

Wiring Diagram

Non Dimmable

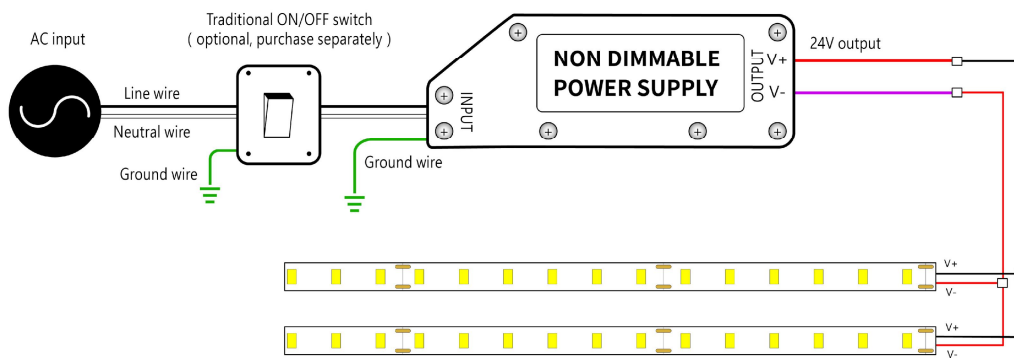

Dimmable

