

# LINIO NEON 1010 3D

Outdoor · Dual Bending · Field Cuttable

# Beamever

## Features

- Field cuttable & joinable
- 3D bending design for curve installations
- High-grade Dow Corning silicone
- UV stable without yellowing or cracking over time
- IP67 rated, ideal for indoor and outdoor uses
- 5 years warranty



Fixture type	
Project name	
Project phase	
Date	



## Dimension & Bending

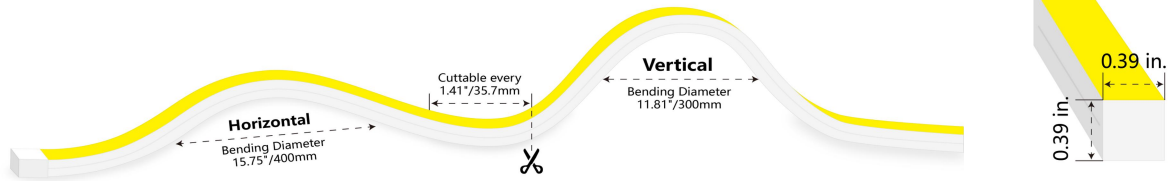

## Physical

Dimensions	0.39" x 0.39" (width x height)
Bend Direction	Dual bending
Bend Diameter	11.81" @Vertical, 15.75" @Horizontal
Cutting Interval	1.41" (35.7mm)
Field Cuttable	Yes
Housing Material	Dow Corning
Housing Technique	Co-extrusion
Body Color	White
Finish	Matte
Feed Entry	Front, side, bottom
Feed Length	Standard length 3.28'
End Cap	Silicone
Mounting	Clips or channel (rigid or bendable)
Storage Temperature	-25~65°C (-13~149°F)
Ambient Temperature	-25~55°C (-13~131°F)
Max. Production Length	32.8ft (10m)

## Performance & Electrical

Voltage	24VDC (23.5Vmin, 24.5Vmax)
Beam Angle	120°
MacAdam	3 steps
Efficacy (lm/W)	49.8lm/W @4000K 3.05W
CRI	Ra > 90
Lumen Maintenance	> 54,000 hours
IP Rating	IP67
Resistance	UV, solvent, saltwater, flame
Dimming	Triac, ELV, PWM, 0-10V, DMX
Warranty	5 years

## Certification & Safety

Certifications	UL
Environment	Dry, damp or wet locations

Lumen/ft	1.52W	3.05W
■ 2700K	74	140
■ 3000K	75	143
■ 3500K	75	143
■ 4000K	80	152
Max. Run Length (ft)	16.4	16.4

\*Other color temperatures and single chromatic colors customizable.

# LINIO NEON 1010 3D

Outdoor · Dual Bending · Field Cuttable



## Order Code

Series	Temp./Color	Power	Feed Entry	Connector Wire	End Cap	Length (ft)
LN10103D	27=2700K 30=3000K 35=3500K 40=4000K	152=1.52W 305=3.05W	FF=Front + Front BB=Bottom + Bottom SS=Side + Side FC=Front + Closed FB=Front + Bottom BF=Bottom+Front FLS=Front + Left Side FRS=Front + Right Side BC=Bottom + Closed BLS=Bottom + Left Side BRS=Bottom + Right Side LSC=Left Side + Closed RSC=Right Side + Closed	OW=Open wire 3.28' MFC=Male & female connector 0.98'	SEC=Silicone end cap (IP67) * End caps are added by default	Min. - 1.41" Max. run - 16.4' Cut Inc. - 1.41"

Example: LN10103D-27-305-FF-OW-SEC-3.28'

\* Customizable—Contact Beamever representatives

## Feed Entry Options

For silicone end cap (IP67)

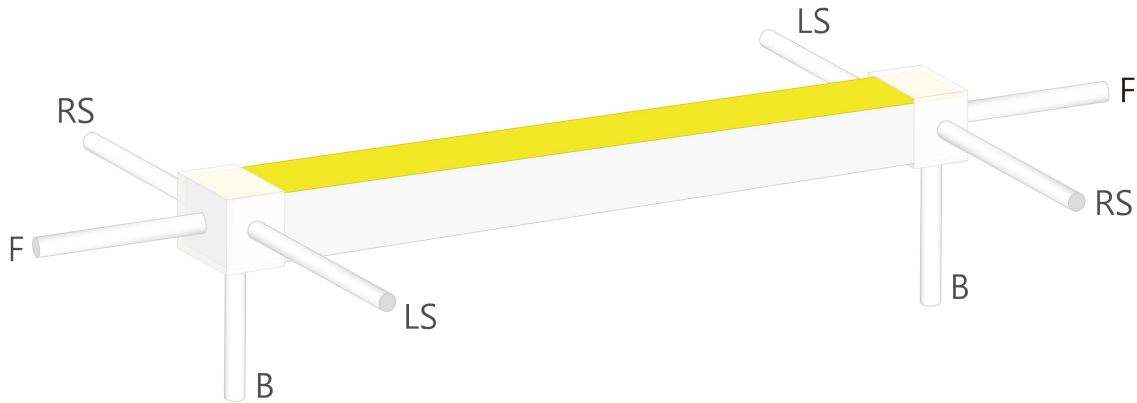

**Mounting Options**

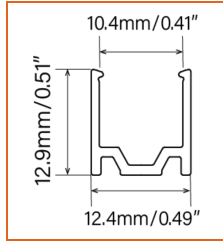

\* Standard length is 3.28'/pcs.

Name	Straight surface channel
Code	LN1010-SC
Material	Aluminum
Mounting style	Surface mounted
Length	3.28' (1m)
Width	0.49" (12.4mm)
Height	0.51" (12.9mm)
Internal width	/

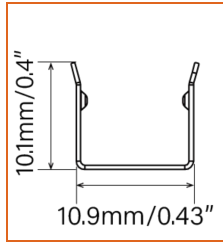
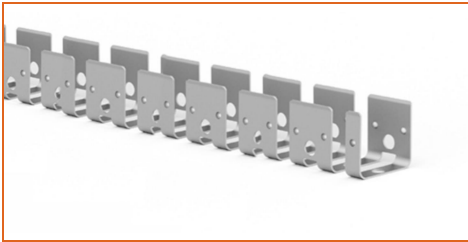

\* Standard length is 1.64'/pcs.

Name	Bendable channel
Code	LN1010-BC
Material	Stainless Steel
Mounting style	Surface mounted
Length	1.64' (0.5m)
Width	0.43" (10.9mm)
Height	0.4" (10.1mm)
Internal Width	/

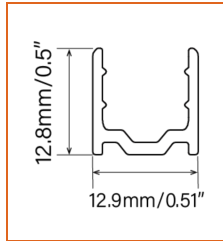

\* Standard length is 3.28'/pcs.

Name	PC channel
Code	LN1010-PC
Material	PC
Mounting style	Surface mounted
Length	3.28' (1m)
Width	0.51" (12.9mm)
Height	0.50" (12.8mm)
Internal width	/

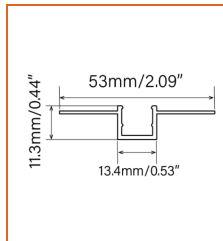

\* Standard length is 3.28'/pcs.

Name	Mud-in channel
Code	LN1010-MC
Material	Aluminum
Mounting style	Mud-in mounted
Length	3.28' (1m)
Width	2.09" (53mm)
Height	0.44" (11.3mm)
Internal width	/

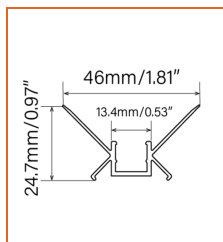

\* Standard length is 3.28'/pcs.

Name	Inside corner channel
Code	LN1010-IC
Material	Aluminum
Mounting style	Mud-in mounted
Length	3.28' (1m)
Width	1.81" (46mm)
Height	0.97" (24.7mm)
Internal width	/

# LINIO NEON 1010 3D

Outdoor · Dual Bending · Field Cuttable

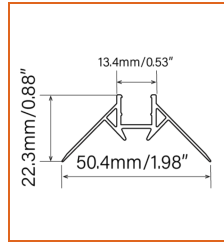

\* Standard length is 3.28' / pcs.

Name	Outside corner channel
Code	LN1010-OC
Material	Aluminum
Mounting style	Mud-in mounted
Length	3.28' (1m)
Width	1.98" (50.4mm)
Height	0.88" (22.3mm)
Internal width	/

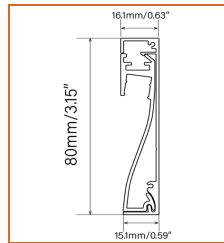

\* Standard length is 3.28' / pcs.

Name	Skirting board channel
Code	LN1010-SBC
Material	Aluminum
Mounting style	Surface mounted
Length	3.28' (1m)
Width	0.63" (16.1mm)
Height	3.15" (80mm)
Internal width	/

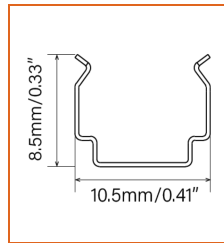

\* Recommend use 1 mounting clip for 1' of neon.

Name	Mounting clip
Code	LN1010-CL
Material	Stainless Steel
Mounting style	Surface mounted
Length	0.28" (7mm)
Width	0.41" (10.5mm)
Height	0.33" (8.5mm)
Internal Width	/

**Driver Options**

Code	Max Load	Input	Output	Dimmable	Class 2	Environment	Size (L*W*H)
<b>Non Dimmable</b>							
KV-24030-ASW	30W	100-277VAC	24V	No	Yes	Dry/damp	6.10*2.12*0.78 inch
KV-24060-ASW	60W	100-277VAC	24V	No	Yes	Dry/damp	7.00*2.40*0.94 inch
KV-24096-ASW	96W	100-277VAC	24V	No	Yes	Dry/damp/wet	9.05*2.75*1.69 inch
KV-24150-ASW	150W	100-277VAC	24V	No	No	Dry/damp/wet	10.07*3.07*1.85 inch
KV-24200-ASW	200W	100-277VAC	24V	No	No	Dry/damp/wet	10.07*3.07*1.85 inch
KV-24300-ASW	300W	100-277VAC	24V	No	No	Dry/damp/wet	10.86*3.07*1.85 inch
<b>Phase cut / Triac Dimmable</b>							
KVF-24030-TDW	30W	100-277VAC	24V	Yes	Yes	Dry/damp	6.10*2.12*0.78 inch
KVF-24060-TDW	60W	100-277VAC	24V	Yes	Yes	Dry/damp	7*2.4*0.94 inch
KVF-24096-TDW	96W	100-277VAC	24V	Yes	Yes	Dry/damp/wet	9.05*2.75*1.69 inch
KVF-24150-TDW	150W	100-277VAC	24V	Yes	No	Dry/damp/wet	10*3.07*1.85 inch
KVF-24200-TDW	200W	100-277VAC	24V	Yes	No	Dry/damp/wet	10*3.07*1.85 inch
KVF-24300-TDW	300W	100-277VAC	24V	Yes	No	Dry/damp/wet	10.87*3.07*1.85 inch
<b>4 in 1 Dimmable (0-10V/1-10V/Potentiometer/10V PWM)</b>							
KVD-24030-DIM	30W	100-277VAC	24V	Yes	Yes	Dry/damp	6.10*2.12*0.78 inch
KVD-24060-DIM	60W	100-277VAC	24V	Yes	Yes	Dry/damp	7.01*2.40*0.94 inch
KVD-24096-DIM	96W	100-277VAC	24V	Yes	Yes	Dry/damp/wet	9.05*2.75*1.69 inch
KVD-24150-DIM	150W	100-277VAC	24V	Yes	No	Dry/damp/wet	10.08*3.07*1.85 inch
KVD-24200-DIM	200W	100-277VAC	24V	Yes	No	Dry/damp/wet	13.38*11.02*7.28 inch
KVD-24300-DIM	300W	100-277VAC	24V	Yes	No	Dry/damp/wet	10.87*3.07*1.89 inch
<b>5 in 1 Dimmable (Triac/0-10V/1-10V/Potentiometer/10V PWM)</b>							
KVG-24030-DW	30W	100-277VAC	24V	Yes	Yes	Dry/damp	6.1*2.13*0.79 inch
KVG-24060-DW	60W	100-277VAC	24V	Yes	Yes	Dry/damp	7.01*2.41*0.94 inch
KVG-24096-DW	96W	100-277VAC	24V	Yes	Yes	Dry/damp/wet	9.06*2.76*1.69 inch
KVG-24150-DW	150W	100-277VAC	24V	Yes	No	Dry/damp/wet	10.08*3.07*1.85 inch
KVG-24200-DW	200W	100-277VAC	24V	Yes	No	Dry/damp/wet	10.08*3.07*1.85 inch
KVG-24300-DW	300W	100-277VAC	24V	Yes	No	Dry/damp/wet	10.87*3.07*1.89 inch

\* Please refer to the spec sheet of each power supply for more detailed information

\* KVF, KVD, KVG series are available in junction box enclosure, you can select it by adding "J" at the end of the driver code, e.g. KVF-24030-TDWJ, and refer to its standalone spec sheet on our website.

**Accessories Options (Optional, purchase for extra)**

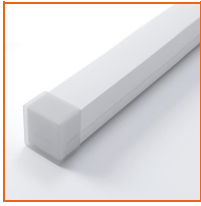

Name Silicone closed end cap  
Code LN1010-SEC-C  
Closed silicone end cap for LINIO NEON 1010 3D

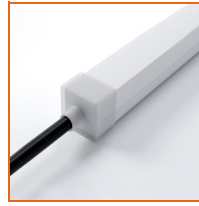

Name Silicone front end cap  
Code LN1010-SEC-F-2P  
Silicone end cap front entry with 11.81" 2 pin cable



Name Silicone side end cap  
Code LN1010-SEC-S-2P  
Silicone end cap side entry with 11.81" 2 pin cable



Name Silicone bottom end cap  
Code LN1010-SEC-B-2P  
Silicone end cap bottom entry with 11.81" 2 pin cable



Name JST male & female connector  
Code JST-2P-67  
JST male and female connector with 7.87" (20cm) cable, IP67, 2 pin



Name Extension connectors  
Code ETC-2P-67-1M  
Extension Male and female connectors with 3.28ft white cable, 2 pin



Name Extension connectors  
Code ETC-2P-67-5M  
Extension Male and female connectors with 16.4ft white cable, 2 pin



Name Silicone glue  
Code SG  
Silicone glue

**Wiring Diagram**

**Non Dimmable**

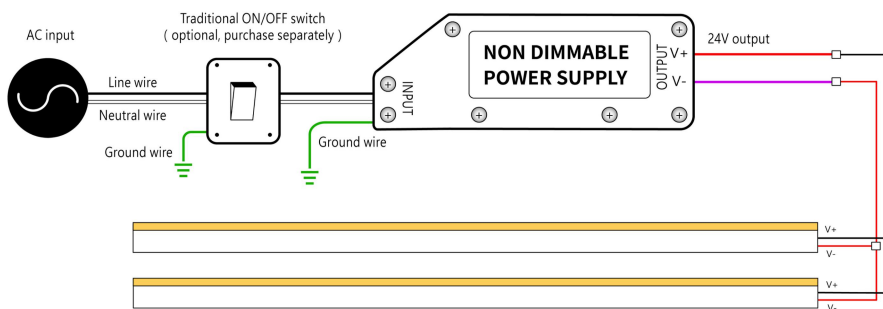

**Dimmable**

