

LINIO NEON 1220 SV BLACK

Outdoor · Horizontal Bending · Black Body

Beamever

Features

- Field cuttable & joinable
- Black color body finish
- Low voltage 24V DC
- Max run length up to 88ft from single power feed
- IP67 rated, ideal for indoor and outdoor uses
- 5 years warranty



Fixture type	
Project name	
Project phase	
Date	

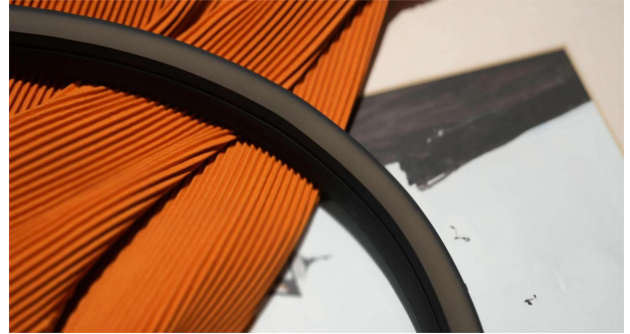

Dimension & Bending

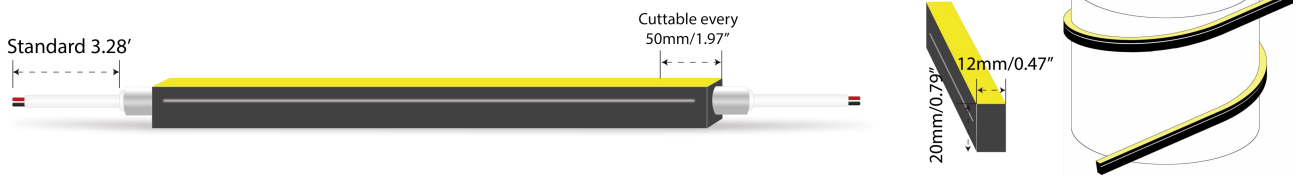

Physical

Dimensions	0.47" x 0.79" (width x height)
Bend Direction	Horizontal bending
Bend Diameter	5.91" (150mm)
Cutting Interval	1.97" (50mm)
Field Cuttable	Yes
Housing Material	Dow Corning
Housing Technique	Co-extrusion
Body Color	Black
Finish	Matte
Feed Entry	Front, side, bottom
Feed Length	Standard length 3.28'
End Cap	Injected (Factory made only)
Mounting	Clips or channel (rigid or bendable)
Storage Temperature	-25~60°C (-13~140°F)
Ambient Temperature	T _{min} = -25°C/-13°F, T _{max} (See below)
Max. Production Length	98.4ft (30m)

Performance & Electrical

Voltage	24VDC (23.5Vmin, 24.5Vmax)
Beam Angle	120°
MacAdam	2 steps
Efficacy (lm/W)	12.2lm/W @4000K 3.05W
CRI	>90
Lumen Maintenance	> 54,000 hours
IP Rating	IP67
Resistance	UV, solvent, saltwater, flame
Dimming	Triac, ELV, PWM, 0-10V, DMX
Warranty	5 years

Certification & Safety

Certifications	UL
Environment	Dry, damp or wet locations

Lumen/ft	1.52W	3.05W	4.57W
■ 2700K	14	35	42
■ 3000K	16	36	48
■ 3500K	16	37	48
■ 4000K	16	40	49
Max. Run Length (ft)	88.6	55.8	45.9
Max. Run for Mechanical End Cap (ft)	65.6	32.8	21.6
Ambient Temperature (T _{max})	55°C/131°F	45°C/113°F	35°C/95°F

* Other color temperatures and single chromatic colors customizable.

LINIO NEON 1220 SV BLACK

Outdoor · Horizontal Bending · Black Body



Order Code

Series	Temp./Color	Power	Feed Entry	Connector Wire	End Cap	Length (ft)
LN1220SVB	27=2700K 30=3000K 35=3500K 40=4000K	152=1.52W 305=3.05W 457=4.57W	FF=Front + Front BB=Bottom + Bottom SS=Side + Side FC=Front + Closed FB=Front + Bottom BF=Bottom+Front FLS=Front + Left Side FRS=Front + Right Side BC=Bottom + Closed BLS=Bottom + Left Side BRS=Bottom + Right Side LSC=Left Side + Closed RSC=Right Side + Closed	OW=Open wire 3.28' MFCB=Male & female connector with 0.98' black cable	IJ=Injected end cap (IP67) MEC=Mechanical end cap (IP67) * End caps are added by default * MEC will reduce max. run length, consult Beamever for specific data	Min. - 1.97" Max. run - 88.6'@1.52W - 55.8'@3.05W - 45.9'@4.57W Cut Inc. - 1.97"

Example: LN1220SVB-27-305-FF-OW-IJ-3.28'

* Customizable—Contact Beamever representatives

Feed Entry Options

For injected end cap (IP67), factory made only

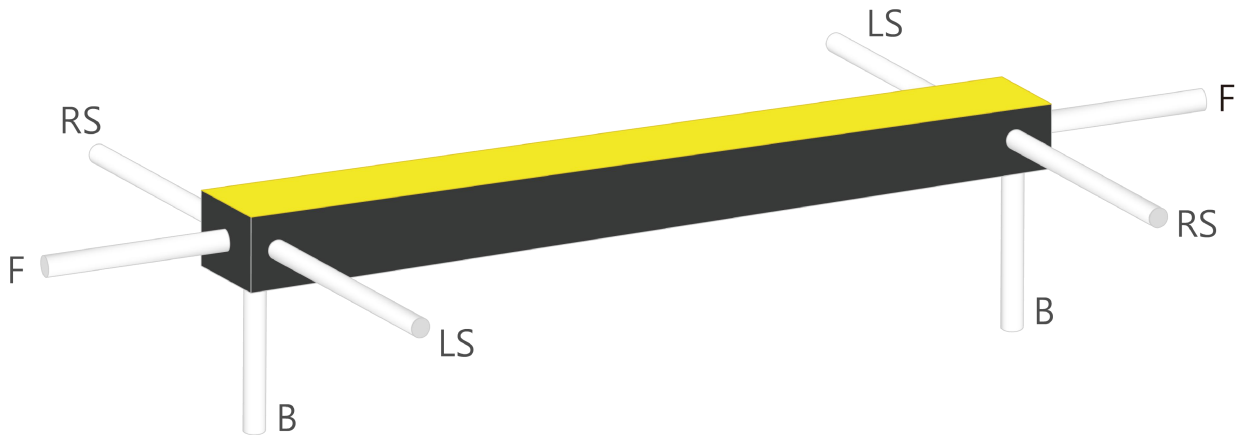

LINIO NEON 1220 SV BLACK

Outdoor · Horizontal Bending · Black Body



Mounting Options



* Standard length is 3.28' / pcs.

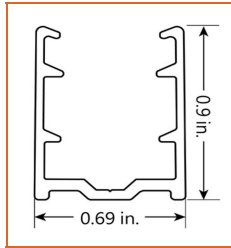

Name	Straight Aluminum channel
Code	LN1220B-SC
Material	Aluminum
Mounting style	Surface mounted
Length	3.28' (1m)
Width	0.69" (17.5mm)
Height	0.9" (22.9mm)
Internal width	/

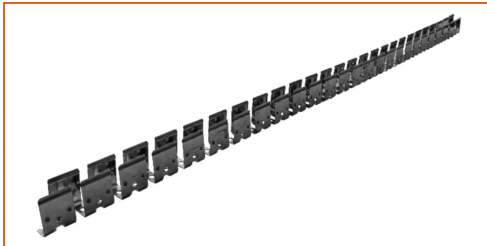

* Standard length is 3.28' / pcs.

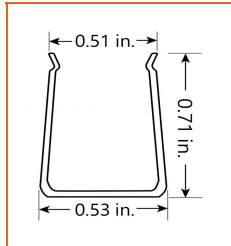

Name	Bendable channel
Code	LN1220B-BC-B
Material	Stainless Steel
Mounting style	Surface mounted
Length	3.28' (1m)
Width	0.53" (13.5mm)
Height	0.71" (18mm)
Internal Width	0.51" (12.9mm)



* Recommend use 1 mounting clip for 1' of neon.

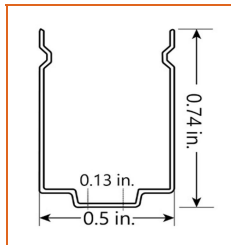

Name	Mounting clip
Code	LN1220B-CL
Material	Stainless Steel
Mounting style	Surface mounted
Length	0.79" (20mm)
Width	0.5" (12.6mm)
Height	0.74" (18.9mm)
Internal Width	/



* Standard length is 3.28' / pcs.

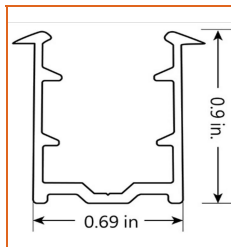

Name	Recessed straight channel
Code	LN1220B-RSC
Material	Aluminum
Mounting style	Recessed mounted
Length	3.28' (1m)
Width	0.69" (17.5mm)
Height	0.9" (22.9mm)
Internal width	/

LINIO NEON 1220 SV BLACK

Outdoor · Horizontal Bending · Black Body



Driver Options

Code	Max Load	Input	Output	Dimmable	Class 2	Environment	Size (L*W*H)
Non Dimmable							
KV-24030-ASW	30W	100-277VAC	24V	No	Yes	Dry/damp	6.10*2.12*0.78 inch
KV-24060-ASW	60W	100-277VAC	24V	No	Yes	Dry/damp	7.00*2.40*0.94 inch
KV-24096-ASW	96W	100-277VAC	24V	No	Yes	Dry/damp/wet	9.05*2.75*1.69 inch
KV-24150-ASW	150W	100-277VAC	24V	No	No	Dry/damp/wet	10.07*3.07*1.85 inch
KV-24200-ASW	200W	100-277VAC	24V	No	No	Dry/damp/wet	10.07*3.07*1.85 inch
KV-24300-ASW	300W	100-277VAC	24V	No	No	Dry/damp/wet	10.86*3.07*1.85 inch
Phase cut / Triac Dimmable							
KVF-24030-TDW	30W	100-277VAC	24V	Yes	Yes	Dry/damp	6.10*2.12*0.78 inch
KVF-24060-TDW	60W	100-277VAC	24V	Yes	Yes	Dry/damp	7*2.4*0.94 inch
KVF-24096-TDW	96W	100-277VAC	24V	Yes	Yes	Dry/damp/wet	9.05*2.75*1.69 inch
KVF-24150-TDW	150W	100-277VAC	24V	Yes	No	Dry/damp/wet	10*3.07*1.85 inch
KVF-24200-TDW	200W	100-277VAC	24V	Yes	No	Dry/damp/wet	10*3.07*1.85 inch
KVF-24300-TDW	300W	100-277VAC	24V	Yes	No	Dry/damp/wet	10.87*3.07*1.85 inch
4 in 1 Dimmable (0-10V/1-10V/Potentiometer/10V PWM)							
KVD-24030-DIM	30W	100-277VAC	24V	Yes	Yes	Dry/damp	6.10*2.12*0.78 inch
KVD-24060-DIM	60W	100-277VAC	24V	Yes	Yes	Dry/damp	7.01*2.40*0.94 inch
KVD-24096-DIM	96W	100-277VAC	24V	Yes	Yes	Dry/damp/wet	9.05*2.75*1.69 inch
KVD-24150-DIM	150W	100-277VAC	24V	Yes	No	Dry/damp/wet	10.08*3.07*1.85 inch
KVD-24200-DIM	200W	100-277VAC	24V	Yes	No	Dry/damp/wet	13.38*11.02*7.28 inch
KVD-24300-DIM	300W	100-277VAC	24V	Yes	No	Dry/damp/wet	10.87*3.07*1.89 inch
5 in 1 Dimmable (Triac/0-10V/1-10V/Potentiometer/10V PWM)							
KVG-24030-DW	30W	100-277VAC	24V	Yes	Yes	Dry/damp	6.1*2.13*0.79 inch
KVG-24060-DW	60W	100-277VAC	24V	Yes	Yes	Dry/damp	7.01*2.41*0.94 inch
KVG-24096-DW	96W	100-277VAC	24V	Yes	Yes	Dry/damp/wet	9.06*2.76*1.69 inch
KVG-24150-DW	150W	100-277VAC	24V	Yes	No	Dry/damp/wet	10.08*3.07*1.85 inch
KVG-24200-DW	200W	100-277VAC	24V	Yes	No	Dry/damp/wet	10.08*3.07*1.85 inch
KVG-24300-DW	300W	100-277VAC	24V	Yes	No	Dry/damp/wet	10.87*3.07*1.89 inch

* Please refer to the spec sheet of each power supply for more detailed information

* KVF, KVD, KVG series are available in junction box enclosure, you can select it by adding "J" at the end of the driver code, e.g. KVF-24030-TDWJ, and refer to its standalone spec sheet on our website.

LINIO NEON 1220 SV BLACK

Outdoor · Horizontal Bending · Black Body



Accessories Options (Optional, purchase for extra)

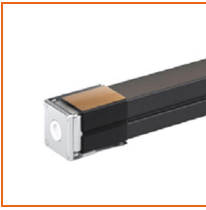

Name Mechanical end cap (G1)

Code LN1220-MEC1-C

Mechanical closed end cap with screws (G1)

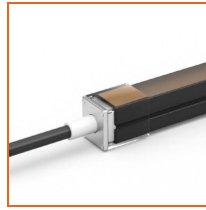

Name Mechanical end cap (G1)

Code LN1220-MEC1-F-2P

Mechanical end cap with screws (G1), front entry with 11.81" black cable, 2 pin



Name Mechanical end cap (G1)

Code LN1220-MEC1-LS-2P

Mechanical end cap with screws (G1), left side entry with 11.81" black cable, 2 pin

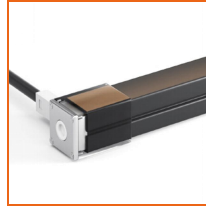

Name Mechanical end cap (G1)

Code LN1220-MEC1-RS-2P

Mechanical end cap with screws (G1), right side entry with 11.81" black cable, 2 pin



Name Mechanical end cap (G1)

Code LN1220-MEC1-B-2P

Mechanical end cap with screws (G1), bottom entry with 11.81" black cable, 2 pin



Name Male and female connectors

Code MFC-2P-67-B

Male and female connectors with 11.81" black cable, 2 pin



Name Extension connectors

Code ETC-2P-67-1M

Extension Male and female connectors with 3.28ft black cable, 2 pin



Name Extension connectors

Code ETC-2P-67-5M

Extension Male and female connectors with 16.4ft black cable, 2 pin

LINIO NEON 1220 SV BLACK

Outdoor · Horizontal Bending · Black Body



Wiring Diagram

Non Dimmable

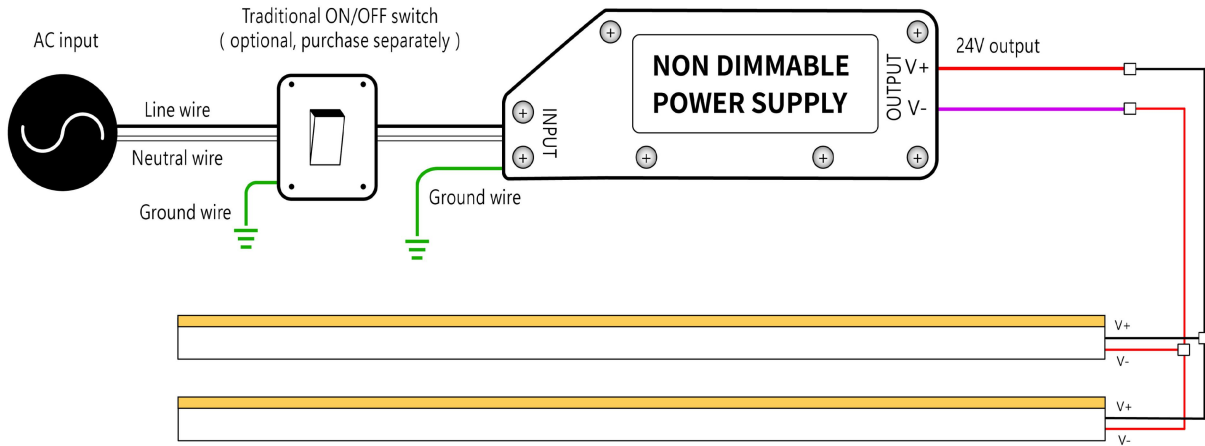

Dimmable

