

AERO TAPE IP65

Indoor · White

Beamever

Features

- IP65 rated for dry and damp locations
- Operates at safe and energy-efficient voltage of DC24V
- Slim and elegant, ideal for indoor applications
- 3M tape on the back makes it easy to install
- Available in a variety of CCT color options
- 5 years warranty



Fixture type	
Project name	
Project phase	
Date	



Dimension & Bending

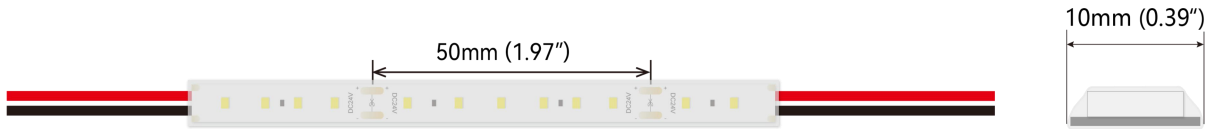

Physical

PCB Width	0.39" (10mm)
LED Pitch	0.33" (8.3mm)
Cutting Interval	1.97" (50mm)
LED Brand	Sanan
LED Size	2835
LED Quantity	36 LEDs/ft (120 LEDs/m)
Adhesive Type	Yellow 3M tape
Feed Entry	Front
Feed Length	Standard length 3.28'
Storage Temperature	-25~60°C (-13~140°F)
Ambient Temperature	-20~45°C (-4~113°F)
Max Production Length	32.8ft (10m)

Performance & Electrical

Voltage	24VDC (23.5Vmin, 24.5Vmax)
Beam Angle	120°
MacAdam	3 steps
Efficacy (lm/W)	97.5lm/W @4000K
CRI	Ra90
Lumen Maintenance	> 54,000 hours
IP Rating	IP65
Resistance	UV, solvent, saltwater, flame
Dimming	Triac, ELV, PWM, 0-10V, DMX
Warranty	5 years

Certification & Safety

Certifications	UL
Environment	Dry, damp or wet locations

Lumen/ft	1.46W	2.93W	4.39W	5.85W	7.32W
■ 2700K	143	277	383	524	644
■ 3000K	148	282	402	536	670
■ 4000K	152	308	422	556	697
■ 6500K	161	375	424	560	688
Max. Run Length (ft)	16.4	16.4	16.4	16.4	16.4

*Other color temperatures and single chromatic colors customizable.

AERO TAPE IP65

Indoor · White



Order Code

Series	Temp./Color	Power	Feed Entry	Connector Wire	IP Rating	Length (ft)
AERO	27=2700K 30=3000K 40=4000K 65=6500K	146=1.46W 293=2.93W 439=4.39W 585=5.85W 732=7.32W	FF=Front + Front FC=Front + Closed	OW=Open wire 3.28' MFC=Male & female connector 0.98'	65=IP65	Min. - 1.97" Max. run - 16.4' Cut Inc. - 1.97"

Example: AERO-30-293-FF-OW-65-3.28'

* Customizable—Contact Beamever representatives

*This product is not rated as submersible. Do not install in a location where water may pool or collect.

Mounting Options

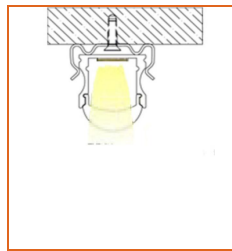
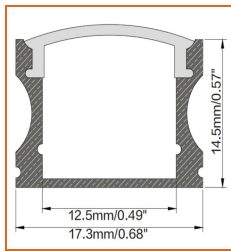
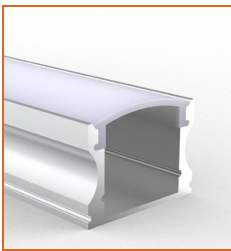

* Standard length is 3.28' /pcs.

Name	Straight aluminum channel
Code	BE1202
Material	Alluminum
Mounting style	Surface mounted
Length	3.28' (1m)
Width	0.68" (17.3mm)
Height	0.57" (14.5mm)
Internal width	0.49" (12.5mm)

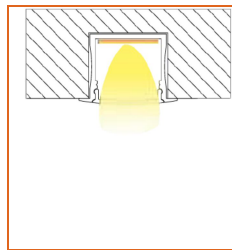
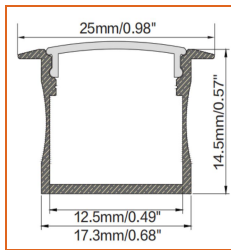
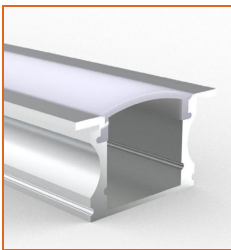

* Standard length is 3.28' /pcs.

Name	Straight aluminum channel
Code	BE1201
Material	Alluminum
Mounting style	Recessed mounted
Length	3.28' (1m)
Width	0.68" (17.3mm)
Height	0.57" (14.5mm)
Internal width	0.49" (12.5mm)

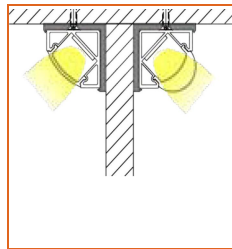
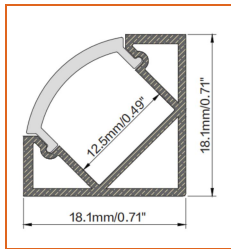
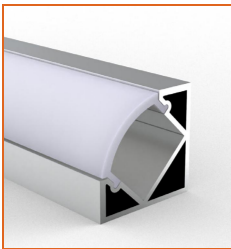

* Standard length is 3.28' /pcs.

Name	Straight aluminum channel
Code	BE1203
Material	Alluminum
Mounting style	Angled mounted
Length	3.28' (1m)
Width	0.71" (18.1mm)
Height	0.71" (18.1mm)
Internal width	0.49" (12.5mm)

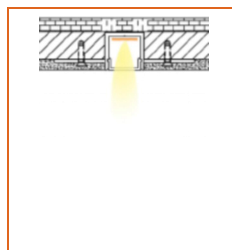
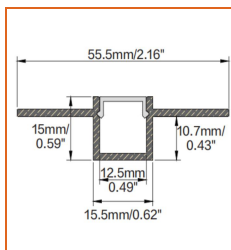
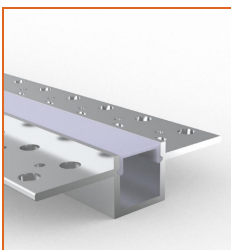

* Standard length is 3.28' /pcs.

Name	Straight aluminum channel
Code	BE5615
Material	Alluminum
Mounting style	Mud-in
Length	3.28' (1m)
Width	0.62" (15.5mm)
Height	0.59" (15mm)
Internal width	0.49" (12.5mm)

* For more options, please refer to "Beamever Profile Spec Sheet"

AERO TAPE IP65

Indoor · White



Driver Options

Code	Max Load	Input	Output	Dimmable	Class 2	Environment	Size (L*W*H)
Non Dimmable							
KV-24030-ASW	30W	100-277VAC	24V	No	Yes	Dry/damp	6.10*2.12*0.78 inch
KV-24060-ASW	60W	100-277VAC	24V	No	Yes	Dry/damp	7.00*2.40*0.94 inch
KV-24096-ASW	96W	100-277VAC	24V	No	Yes	Dry/damp/wet	9.05*2.75*1.69 inch
KV-24150-ASW	150W	100-277VAC	24V	No	No	Dry/damp/wet	10.07*3.07*1.85 inch
KV-24200-ASW	200W	100-277VAC	24V	No	No	Dry/damp/wet	10.07*3.07*1.85 inch
KV-24300-ASW	300W	100-277VAC	24V	No	No	Dry/damp/wet	10.86*3.07*1.85 inch
Phase cut /Triac Dimmable							
KVF-24030-TDW	30W	100-277VAC	24V	Yes	Yes	Dry/damp	6.10*2.12*0.78 inch
KVF-24060-TDW	60W	100-277VAC	24V	Yes	Yes	Dry/damp	7*2.4*0.94 inch
KVF-24096-TDW	96W	100-277VAC	24V	Yes	Yes	Dry/damp/wet	9.05*2.75*1.69 inch
KVF-24150-TDW	150W	100-277VAC	24V	Yes	No	Dry/damp/wet	10*3.07*1.85 inch
KVF-24200-TDW	200W	100-277VAC	24V	Yes	No	Dry/damp/wet	10*3.07*1.85 inch
KVF-24300-TDW	300W	100-277VAC	24V	Yes	No	Dry/damp/wet	10.87*3.07*1.85 inch
4 in 1 Dimmable (0-10V/1-10V/Potentiometer/10V PWM)							
KVD-24030-DIM	30W	100-277VAC	24V	Yes	Yes	Dry/damp	6.10*2.12*0.78 inch
KVD-24060-DIM	60W	100-277VAC	24V	Yes	Yes	Dry/damp	7.01*2.40*0.94 inch
KVD-24096-DIM	96W	100-277VAC	24V	Yes	Yes	Dry/damp/wet	9.05*2.75*1.69 inch
KVD-24150-DIM	150W	100-277VAC	24V	Yes	No	Dry/damp/wet	10.08*3.07*1.85 inch
KVD-24200-DIM	200W	100-277VAC	24V	Yes	No	Dry/damp/wet	13.38*11.02*7.28 inch
KVD-24300-DIM	300W	100-277VAC	24V	Yes	No	Dry/damp/wet	10.87*3.07*1.89 inch
5 in 1 Dimmable (Triac/0-10V/1-10V/Potentiometer/10V PWM)							
KVG-24030-DW	30W	100-277VAC	24V	Yes	Yes	Dry/damp	6.1*2.13*0.79 inch
KVG-24060-DW	60W	100-277VAC	24V	Yes	Yes	Dry/damp	7.01*2.41*0.94 inch
KVG-24096-DW	96W	100-277VAC	24V	Yes	Yes	Dry/damp/wet	9.06*2.76*1.69 inch
KVG-24150-DW	150W	100-277VAC	24V	Yes	No	Dry/damp/wet	10.08*3.07*1.85 inch
KVG-24200-DW	200W	100-277VAC	24V	Yes	No	Dry/damp/wet	10.08*3.07*1.85 inch
KVG-24300-DW	300W	100-277VAC	24V	Yes	No	Dry/damp/wet	10.87*3.07*1.89 inch

* Please refer to the spec sheet of each power supply for more detailed information

* KVF, KVD, KVG series are available in junction box enclosure, you can select it by adding "J" at the end of the driver code, e.g. KVF-24030-TDWJ, and refer to its standalone spec sheet on our website.

AERO TAPE IP65

Indoor · White



Accessories Options (Optional)



Name Male & female connector

Code MFC-2P-20

Male and female connector with 11.81" cable, IP20, 2 pin



Name Male & female DC connector

Code MFC-DC-44

Male and female DC connector with 11.81" cable, IP44

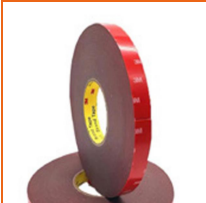

Name VHB 3M adhesive tape

Code VHB

VHB 3M adhesive back tape, stronger stickiness.

Wiring Diagram

Non Dimmable

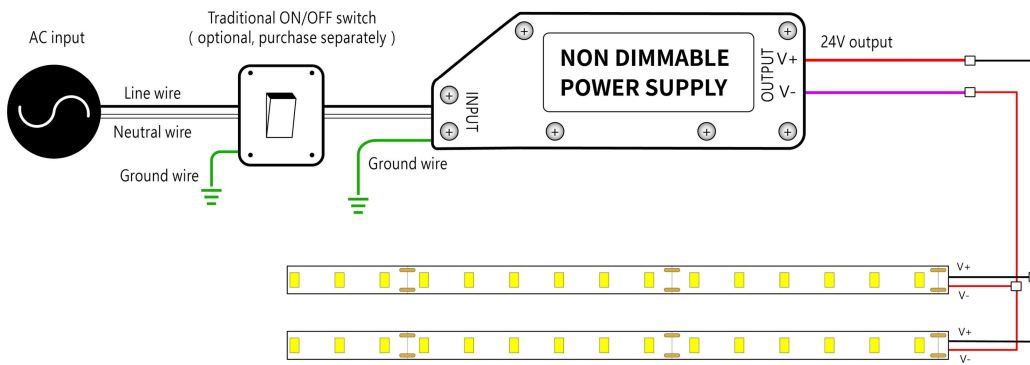

Dimmable

