

AERO TAPE SAUNA

Indoor · White · High-temperature

Beamever

Features

- IP65 rated for dry and damp locations
- Operates in temperature up to 100°C (212°F)
- Slim and elegant, ideal for indoor applications
- 3M tape on the back makes it easy to install
- Available in a variety of CCT color options
- 5 years warranty

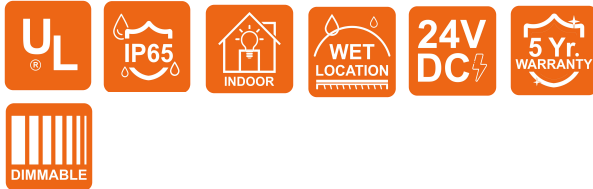

| | |
|---------------|--|
| Fixture type | |
| Project name | |
| Project phase | |
| Date | |



Dimension & Bending

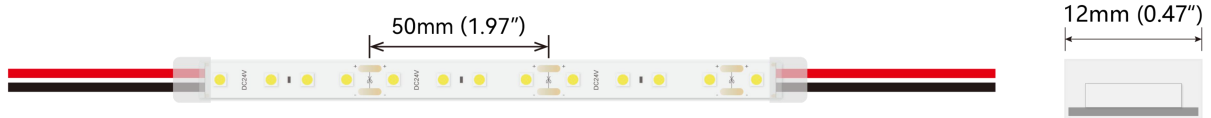

Physical

| | |
|-----------------------|------------------------|
| PCB Width | 0.39" (10mm) |
| LED Pitch | 0.49" (12.5mm) |
| Cutting Interval | 1.97" (50mm) |
| LED Brand | Sanan |
| LED Size | 3030 |
| LED Quantity | 24 LEDs/ft (80 LEDs/m) |
| Adhesive Type | Yellow 3M tape |
| Feed Entry | Front |
| Feed Length | Standard length 3.28' |
| Storage Temperature | -25~100°C (-13~212°F) |
| Ambient Temperature | -25~100°C (-13~212°F) |
| Max Production Length | 98.4ft (30m) |

Performance & Electrical

| | |
|-------------------|-------------------------------|
| Voltage | 24VDC (23.5Vmin, 24.5Vmax) |
| Beam Angle | 120° |
| MacAdam | 3 steps |
| Efficacy (lm/W) | 177.8lm/W @4000K 2.93W |
| CRI | Ra80 |
| Lumen Maintenance | > 54,000 hours |
| IP Rating | IP65 |
| Resistance | UV, solvent, saltwater, flame |
| Dimming | Triac, ELV, PWM, 0-10V, DMX |
| Warranty | 5 years |

Certification & Safety

| | |
|----------------|----------------------------|
| Certifications | UL |
| Environment | Dry, damp or wet locations |

| Lumen/ft | 1.46W | 2.93W |
|----------------------|-------|-------|
| ■ 2700K | 181 | 344 |
| ■ 3000K | 192 | 365 |
| ■ 4000K | 197 | 376 |
| ■ 5000K | 197 | 376 |
| ■ 6500K | 197 | 376 |
| Max. Run Length (ft) | 16.4 | 16.4 |

*Other color temperatures and single chromatic colors customizable.

AERO TAPE SAUNA

Indoor · White · High-temperature



Order Code

| Series | Temp./Color | Power | Feed Entry | Connector Wire | IP Rating | Length (ft) |
|--------|--|------------------------|---------------------------------------|---|-----------|--|
| AEROS | 27=2700K 30=3000K 40=4000K 50=5000K 65=6500K | 146=1.46W 293=2.93W | FF=Front + Front FC=Front + Closed | OW=Open wire 3.28' MFC=Male & female connector 0.98' | 65=IP65 | Min. - 1.97" Max. run - 16.4' Cut Inc. - 1.97" |

Example: AEROS-30-293-FF-OW-65-3.28'

* Customizable—Contact Beamever representatives

*This product is not rated as submersible. Do not install in a location where water may pool or collect.

Mounting Options

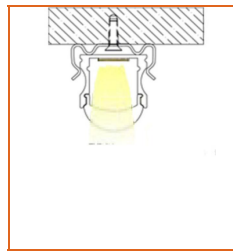
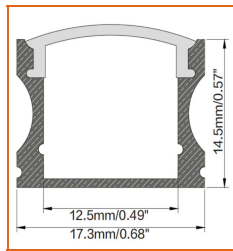
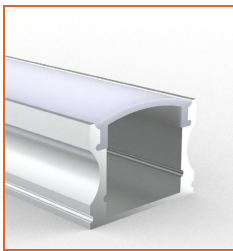

* Standard length is 3.28' /pcs.

| | |
|----------------|----------------------------|
| Name | Straight alluminum channel |
| Code | BE1202 |
| Material | Alluminum |
| Mounting style | Surface mounted |
| Length | 3.28' (1m) |
| Width | 0.68" (17.3mm) |
| Height | 0.57" (14.5mm) |
| Internal width | 0.49" (12.5mm) |

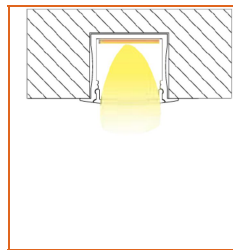
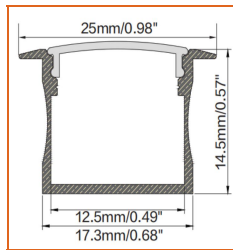
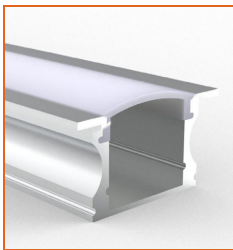

* Standard length is 3.28' /pcs.

| | |
|----------------|----------------------------|
| Name | Straight alluminum channel |
| Code | BE1201 |
| Material | Alluminum |
| Mounting style | Recessed mounted |
| Length | 3.28' (1m) |
| Width | 0.68" (17.3mm) |
| Height | 0.57" (14.5mm) |
| Internal width | 0.49" (12.5mm) |

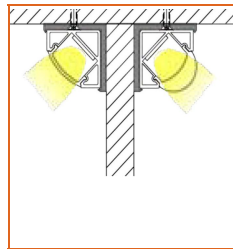
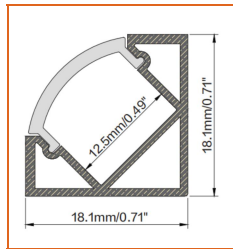
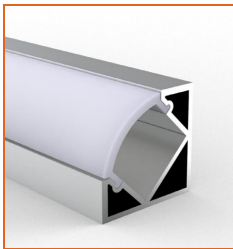

* Standard length is 3.28' /pcs.

| | |
|----------------|----------------------------|
| Name | Straight alluminum channel |
| Code | BE1203 |
| Material | Alluminum |
| Mounting style | Angled mounted |
| Length | 3.28' (1m) |
| Width | 0.71" (18.1mm) |
| Height | 0.71" (18.1mm) |
| Internal width | 0.49" (12.5mm) |

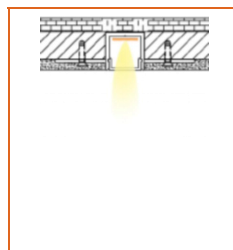
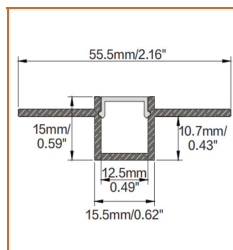
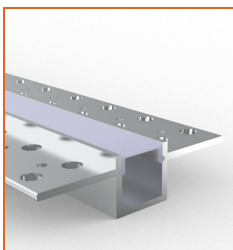

* Standard length is 3.28' /pcs.

| | |
|----------------|----------------------------|
| Name | Straight alluminum channel |
| Code | BE5615 |
| Material | Alluminum |
| Mounting style | Mud-in |
| Length | 3.28' (1m) |
| Width | 0.62" (15.5mm) |
| Height | 0.59" (15mm) |
| Internal width | 0.49" (12.5mm) |

AERO TAPE SAUNA

Indoor · White · High-temperature



* For more options, please refer to "Beamever Profile Spec Sheet"

Driver Options

| Code | Max Load | Input | Output | Dimmable | Class 2 | Environment | Size (L*W*H) |
|--|----------|------------|--------|----------|---------|--------------|-----------------------|
| Non Dimmable | | | | | | | |
| KV-24030-ASW | 30W | 100-277VAC | 24V | No | Yes | Dry/damp | 6.10*2.12*0.78 inch |
| KV-24060-ASW | 60W | 100-277VAC | 24V | No | Yes | Dry/damp | 7.00*2.40*0.94 inch |
| KV-24096-ASW | 96W | 100-277VAC | 24V | No | Yes | Dry/damp/wet | 9.05*2.75*1.69 inch |
| KV-24150-ASW | 150W | 100-277VAC | 24V | No | No | Dry/damp/wet | 10.07*3.07*1.85 inch |
| KV-24200-ASW | 200W | 100-277VAC | 24V | No | No | Dry/damp/wet | 10.07*3.07*1.85 inch |
| KV-24300-ASW | 300W | 100-277VAC | 24V | No | No | Dry/damp/wet | 10.86*3.07*1.85 inch |
| Phase cut /Triac Dimmable | | | | | | | |
| KVF-24030-TDW | 30W | 100-277VAC | 24V | Yes | Yes | Dry/damp | 6.10*2.12*0.78 inch |
| KVF-24060-TDW | 60W | 100-277VAC | 24V | Yes | Yes | Dry/damp | 7*2.4*0.94 inch |
| KVF-24096-TDW | 96W | 100-277VAC | 24V | Yes | Yes | Dry/damp/wet | 9.05*2.75*1.69 inch |
| KVF-24150-TDW | 150W | 100-277VAC | 24V | Yes | No | Dry/damp/wet | 10*3.07*1.85 inch |
| KVF-24200-TDW | 200W | 100-277VAC | 24V | Yes | No | Dry/damp/wet | 10*3.07*1.85 inch |
| KVF-24300-TDW | 300W | 100-277VAC | 24V | Yes | No | Dry/damp/wet | 10.87*3.07*1.85 inch |
| 4 in 1 Dimmable (0-10V/1-10V/Potentiometer/10V PWM) | | | | | | | |
| KVD-24030-DIM | 30W | 100-277VAC | 24V | Yes | Yes | Dry/damp | 6.10*2.12*0.78 inch |
| KVD-24060-DIM | 60W | 100-277VAC | 24V | Yes | Yes | Dry/damp | 7.01*2.40*0.94 inch |
| KVD-24096-DIM | 96W | 100-277VAC | 24V | Yes | Yes | Dry/damp/wet | 9.05*2.75*1.69 inch |
| KVD-24150-DIM | 150W | 100-277VAC | 24V | Yes | No | Dry/damp/wet | 10.08*3.07*1.85 inch |
| KVD-24200-DIM | 200W | 100-277VAC | 24V | Yes | No | Dry/damp/wet | 13.38*11.02*7.28 inch |
| KVD-24300-DIM | 300W | 100-277VAC | 24V | Yes | No | Dry/damp/wet | 10.87*3.07*1.89 inch |
| 5 in 1 Dimmable (Triac/0-10V/1-10V/Potentiometer/10V PWM) | | | | | | | |
| KVG-24030-DW | 30W | 100-277VAC | 24V | Yes | Yes | Dry/damp | 6.1*2.13*0.79 inch |
| KVG-24060-DW | 60W | 100-277VAC | 24V | Yes | Yes | Dry/damp | 7.01*2.41*0.94 inch |
| KVG-24096-DW | 96W | 100-277VAC | 24V | Yes | Yes | Dry/damp/wet | 9.06*2.76*1.69 inch |
| KVG-24150-DW | 150W | 100-277VAC | 24V | Yes | No | Dry/damp/wet | 10.08*3.07*1.85 inch |
| KVG-24200-DW | 200W | 100-277VAC | 24V | Yes | No | Dry/damp/wet | 10.08*3.07*1.85 inch |
| KVG-24300-DW | 300W | 100-277VAC | 24V | Yes | No | Dry/damp/wet | 10.87*3.07*1.89 inch |

* Please refer to the spec sheet of each power supply for more detailed information

* KVF, KVD, KVG series are available in junction box enclosure, you can select it by adding "J" at the end of the driver code, e.g. KVF-24030-TDWJ, and refer to its standalone spec sheet on our website.

Accessories Options (Optional)



Name Mounting clip
Code AERO-CL-12
Mounting clip for SMD series, IP65



Name Silicone closed end cap
Code AERO-SEC-C-12
Closed silicone end cap, IP65



Name Silicone glue
Code SG
Silicone glue

Wiring Diagram

Non Dimmable

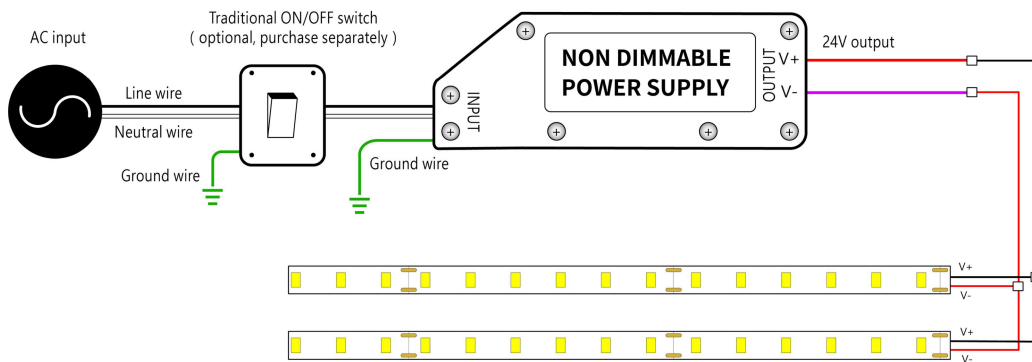

Dimmable

