

LINIO NEON 1617 TV RGB

Outdoor · RGB · Vertical Bending

Beamever

Features

- Factory assembly
- Low voltage 24V DC
- RGB allows for versatile lighting effects
- Max run length up to 43ft from single power feed
- IP67 rated, ideal for indoor and outdoor uses
- UV stable without yellowing or cracking over time



Fixture type	
Project name	
Project phase	
Date	



Dimension & Bending

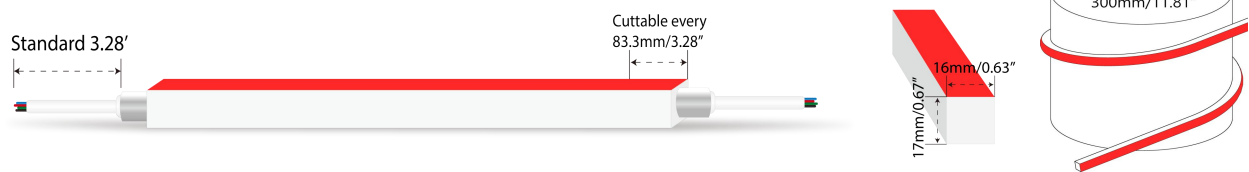

Physical

Dimensions	0.63" x 0.67" (width x height)
Bend Direction	Vertical bending
Bend Diameter	11.81" (300mm)
Cutting Interval	3.28" (83.3mm)
Field Cuttable	Yes
Housing Material	Dow Corning
Housing Technique	Co-extrusion
Body Color	White
Finish	Matte
Feed Entry	Front, side, bottom
Feed Length	Standard length 3.28'
End Cap	Injected/silicone/mechanical
Mounting	Clips or channels (rigid or bendable)
Storage Temperature	-25~60°C (-13~140°F)
Ambient Temperature	-25~45°C (-13~113°F)
Max. Production Length	98.4ft (30m)

Performance & Electrical

Voltage	24VDC (23.5Vmin, 24.5Vmax)
Beam Angle	110°
Efficacy (lm/W)	27.2lm/W @RGB 3.9W
Lumen Maintenance	> 30,000 hours
IP Rating	IP67
Resistance	UV, solvent, saltwater, flame
Dimming	DMX
Warranty	5 years

Certification & Safety

Certifications	UL
Environment	Dry, damp or wet locations

Lumen/ft	3.9W
■ R	32
■ G	62
■ B	12
■ RGB	106
Max. Run Length(ft)	42.6

LINIO NEON 1617 TV RGB

Outdoor · RGB · Vertical Bending



Order Code

Series	Temp./Color	Power	Feed Entry	Connector Wire	End Cap	Length (ft)
LN1617TV	RGB	390=3.9W	FF=Front + Front BB=Bottom + Bottom SS=Side + Side FC=Front + Closed FB=Front + Bottom BF=Bottom+Front FLS=Front + Left Side FRS=Front + Right Side BC=Bottom + Closed BLS=Bottom + Left Side BRS=Bottom + Right Side LSC=Left Side + Closed RSC=Right Side + Closed	OW=Open wire 3.28' MFCW=Male & female connector with 0.98' white cable MFCB=Male & female connector with 0.98' black cable	IJ=Injected end cap (IP67) * Factory made only SEC=Silicone end cap (IP67) MEC=Mechanical end cap (IP67) * End caps are added by default	Min. - 3.28" Max. run - 42.6' Cut Inc. - 3.28"

Example: LN1617TV-RGB-390-FF-OW-IJ-3.28'

* Customizable—Contact Beamever representatives

* Do not install in an environment that is permanently flooded with water or high in humidity, as damage to the neon will occur.

Feed Entry Options

For injected end cap (IP67), factory made only

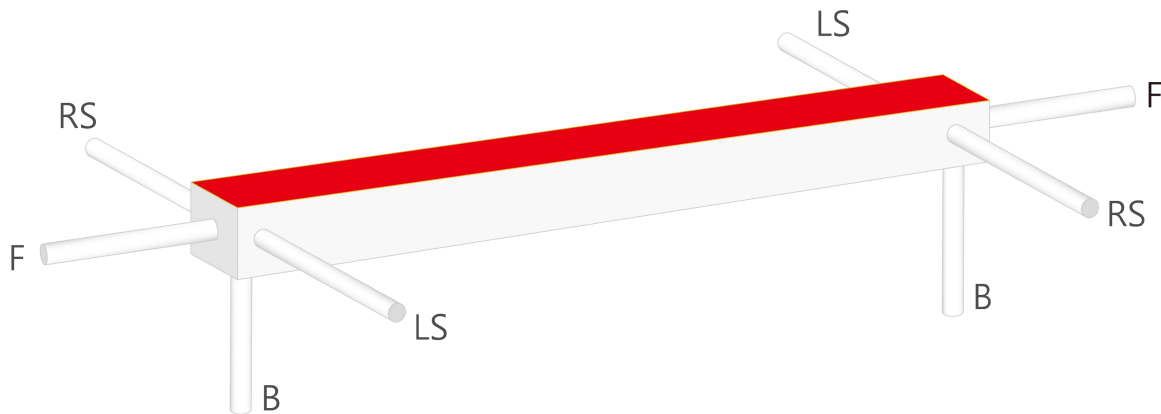

For silicone end cap / mechanical end cap (IP67)

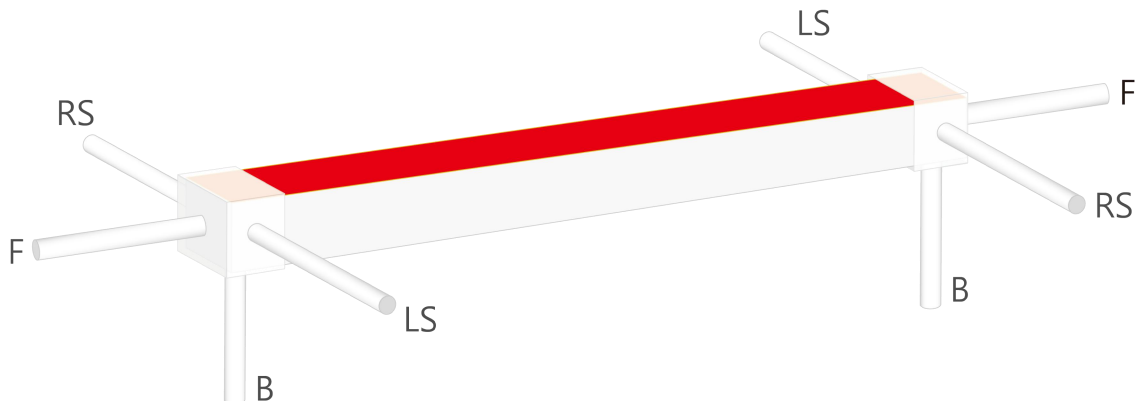

LINIO NEON 1617 TV RGB

Outdoor · RGB · Vertical Bending



Mounting Options

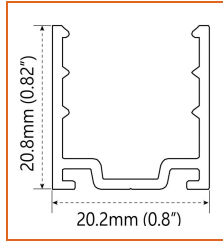

* Standard length is 3.28' / pcs.

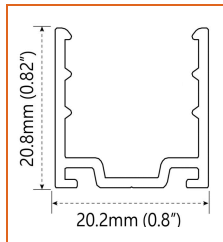
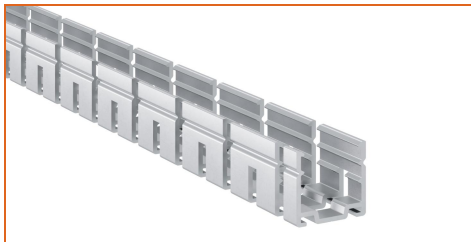

* Standard length is 3.28' / pcs.

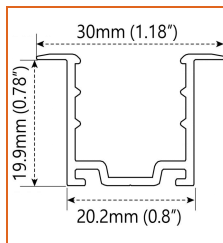

* Standard length is 3.28' / pcs.

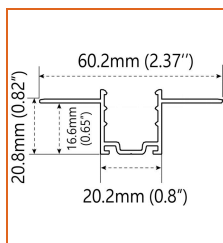

* Standard length is 3.28' / pcs.

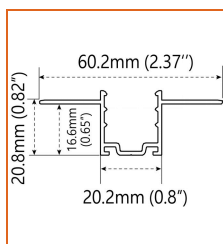
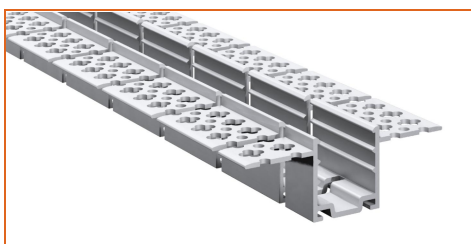

* Standard length is 3.28' / pcs.

Name	Straight surface channel
Code	LN1617-SC
Material	Aluminum
Mounting style	Surface mounted
Length	3.28' (1m)
Width	0.8" (20.2mm)
Height	0.82" (20.8mm)
Internal width	/

Name	Bendable surface channel
Code	LN1617-BC
Material	Aluminum
Mounting style	Surface mounted
Length	3.28' (1m)
Width	0.8" (20.2mm)
Height	0.82" (20.8mm)
Internal Width	/

Name	Straight recessed channel
Code	LN1617-RSC
Material	Aluminum
Mounting style	Recessed mounted
Length	3.28' (1m)
Width	1.18" (30mm)
Height	0.78" (19.9mm)
Internal width	/

Name	Mud-in channel
Code	LN1617-MC
Material	Aluminum
Mounting style	Mud-in mounted
Length	3.28' (1m)
Width	2.37" (60.2mm)
Height	0.65" (16.6mm)
Internal Width	/

Name	Bendable mud-in channel
Code	LN1617-BMC
Material	Aluminum
Mounting style	Mud-in mounted
Length	3.28' (1m)
Width	2.37" (60.2mm)
Height	0.65" (16.6mm)
Internal Width	/

LINIO NEON 1617 TV RGB

Outdoor · RGB · Vertical Bending

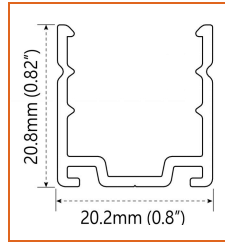
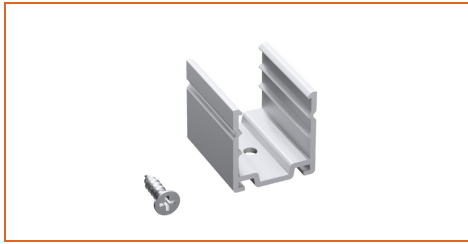

* Recommend use 1 mounting clip for 1' of neon.

Name	Mounting clip
Code	LN1617-CL
Material	Aluminum
Mounting style	Surface mounted
Length	0.98" (25mm)
Width	0.8" (20.2mm)
Height	0.82" (20.8mm)
Internal Width	/

Driver Options

Code	Max Load	Input	Output	Dimmable	Class 2	Environment	Size (L*W*H)
Non Dimmable							
KV-24096-ASW	96W	100-277VAC	24V	No	Yes	Dry/damp/wet	9.05*2.75*1.69 inch
KV-24150-ASW	150W	100-277VAC	24V	No	No	Dry/damp/wet	10.07*3.07*1.85 inch
KV-24200-ASW	200W	100-277VAC	24V	No	No	Dry/damp/wet	10.07*3.07*1.85 inch
KV-24300-ASW	300W	100-277VAC	24V	No	No	Dry/damp/wet	10.86*3.07*1.85 inch
DMX512 Dimmable							
KVX-24096-3C-A	96W	100-277VAC	24V	Yes	Yes	Dry/damp/wet	9.05*3.07*0.98 inch
KVX-24150-3C-A	150W	100-277VAC	24V	Yes	No	Dry/damp/wet	10.9*3.07*0.98 inch
KVX-24200-3C-A	200W	100-277VAC	24V	Yes	No	Dry/damp/wet	10.9*3.07*0.98 inch
KVX-24300-3C-A	300W	100-277VAC	24V	Yes	No	Dry/damp/wet	11.85*3.07*0.98 inch

* Please refer to the spec sheet of each power supply for more detailed information

DMX Decoder Options

Code	Description
LT-903	3 channels output, up to 576W output power
LT-912	12 channels output, up to 1152W output power
LT-924	24 channels output, up to 1728W output power

* Please refer to the spec sheet of each decoder for more detailed information

Controller Options

Code	Description
DINA-DR micro	DMX 60 channels, DMX Stand Alone controller with 10 scenes, USB connectivity for programming
SLESA-U9	DMX 256 channels, USB connection, stand alone mode with 1 area and 20 scenes
STICK-GA2	DMX 512 channels, ready to use (pre-loaded with 8 scenes and 170 RGB fixtures)
STICK-CW4	DMX 1024 channels, up to 36 scenes stored and directly recalled via 6 touch sensitive buttons

* Please refer to the spec sheet of each controller for more detailed information

Accessories Options (Optional, purchase for extra)



Name Silicone closed end cap

Code LN1617-SEC-C

Closed silicone end cap

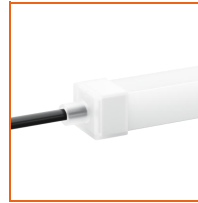

Name Silicone front end cap

Code LN1617-SEC-F-4P

Silicone end cap front entry with 11.81" black cable, 4 pin



Name Silicone side end cap

Code LN1617-SEC-S-4P

Silicone end cap side entry with 11.81" black cable, 4 pin



Name Silicone bottom end cap

Code LN1617-SEC-B-4P

Silicone end cap bottom entry with 11.81" black cable, 4 pin

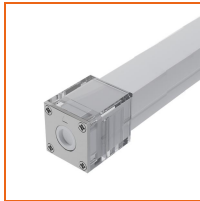

Name Mechanical end cap

Code LN1617-MEC-C

Mechanical closed end cap with screws

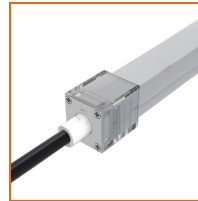

Name Mechanical end cap

Code LN1617-MEC-F-4P

Mechanical end cap with screws, front entry with 11.81" black cable, 4 pin

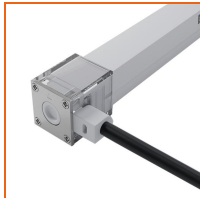

Name Mechanical end cap

Code LN1617-MEC-LS-4P

Mechanical end cap with screws, left side entry with 11.81" black cable, 4 pin

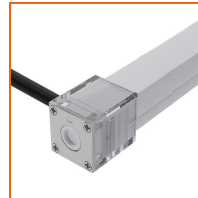

Name Mechanical end cap

Code LN1617-MEC-RS-4P

Mechanical end cap with screws, right side entry with 11.81" black cable, 4 pin



Name Mechanical end cap

Code LN1617-MEC-B-4P

Mechanical end cap with screws, bottom entry with 11.81" black cable, 4 pin



Name Jumper connector

Code LN1617-JC-4P-67

Jumper connector with 2.76"(7cm) white cable, 4 pin, IP67



Name Male and female connectors

Code MFC-4P-67-W

Male and female connectors with 11.81" white cable, 4 pin



Name Male and female connectors

Code MFC-4P-67-B

Male and female connectors with 11.81" black cable, 4 pin



Name Extension connectors

Code ETC-4P-67-1M

Extension Male and female connectors with 1m (3.28ft) white cable, 4 pin



Name Extension connectors

Code ETC-4P-67-5M

Extension Male and female connectors with 5m (16.4ft) white cable, 4 pin

LINIO NEON 1617 TV RGB

Outdoor · RGB · Vertical Bending



Wiring Diagram

Nicolaudie + DMX Control System

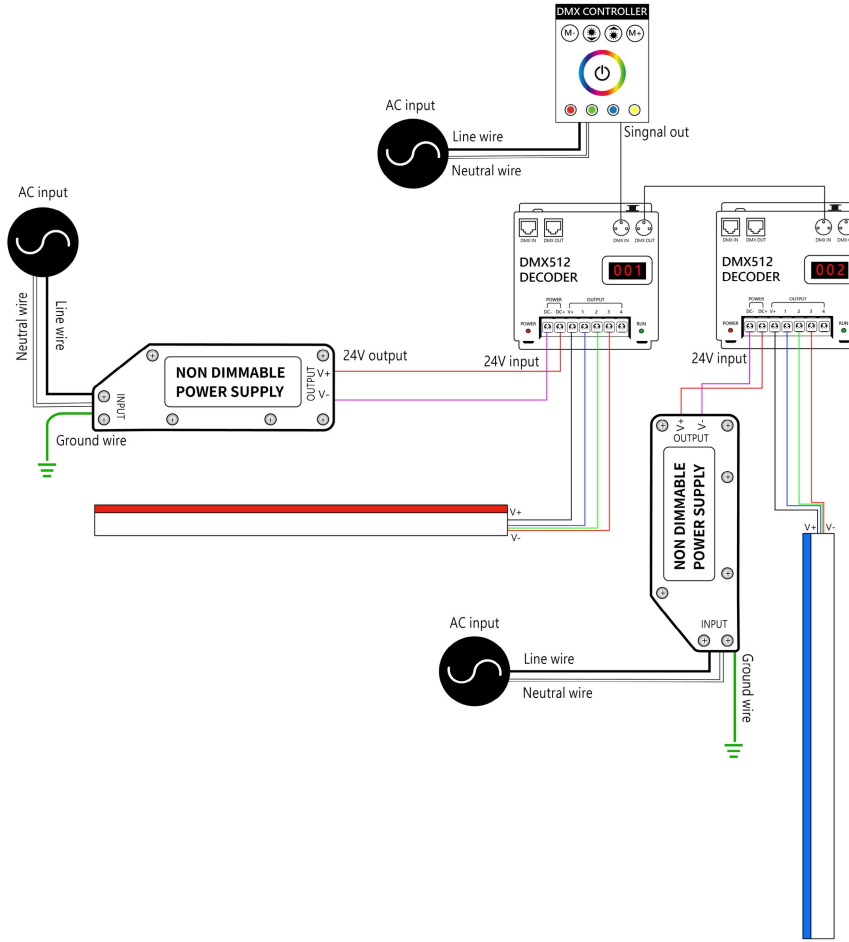

Nicolaudie + DMX Driver System

