

LINIO NEON 0612X SV

Outdoor · Horizontal Bending · Field cuttable

Beamever

Features

- Field cuttable & joinable
- Low voltage 24V DC
- All dimming protocols dimmable
- Max run length up to 43ft from single power feed
- IP67 rated, ideal for indoor and outdoor uses
- UV stable without yellowing or cracking over time



Fixture type	
Project name	
Project phase	
Date	



Dimension & Bending

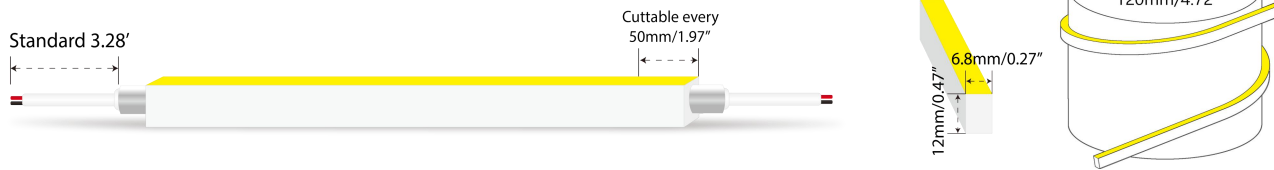

Physical

Dimensions	0.27" x 0.47" (width x height)
Bend Direction	Horizontal bending
Bend Diameter	4.72" (120mm)
Cutting Interval	1.97" (50mm)
Field Cuttable	Yes
Housing Material	Dow Corning
Housing Technique	Co-extrusion
Body Color	White
Finish	Matte
Feed Entry	Front, side, bottom
Feed Length	Standard length 3.28'
End Cap	Injected/silicone
Mounting	Clips or channels (rigid or bendable)
Storage Temperature	-25°C ~ -60°C (-13°F ~ 140°F)
Ambient Temperature	-25°C ~ 45°C (-13°F ~ 113°F)
Max. Production Length	98.4ft (30m)

Performance & Electrical

Voltage	24VDC (23.5Vmin, 24.5Vmax)
Beam Angle	110°
MacAdam	2 steps
Efficacy (lm/W)	39.6lm/W @3000K 2.93W
CRI	Ra>90
Lumen Maintenance	> 54,000 hours
IP Rating	IP67
Resistance	UV, solvent, saltwater, flame
Dimming	Triac, ELV, PWM, 0-10V, DMX, SPI
Warranty	5 years

Certification & Safety

Certifications	UL
Environment	Dry, damp or wet locations

Lumen/ft	2.93W
■ 2200K	96
■ 2700K	109
■ 3000K	116
■ 3500K	116
■ 4000K	112
■ 5300K	109
Max. Run Length (ft)	42.6

LINIO NEON 0612X SV

Outdoor · Horizontal Bending · Field cuttable



Order Code

Series	Temp./Color	Power	Feed Entry	Connector Wire	End Cap	Length (ft)
LN0612XSV	22=2200K 27=2700K 30=3000K 35=3500K 40=4000K 53=5300K	293=2.93W	FF=Front + Front BB=Bottom + Bottom SS=Side + Side FC=Front + Closed FB=Front + Bottom BF=Bottom+Front FLS=Front + Left Side FRS=Front + Right Side BC=Bottom + Closed BLS=Bottom + Left Side BRS=Bottom + Right Side LSC=Left Side + Closed RSC=Right Side + Closed	OW=Open wire 3.28' MFCW=Male & female connector with 0.98' white cable MFCB=Male & female connector with 0.98' black cable	IJ=Injected end cap (IP67) * Factory made only SEC=Silicone end cap (IP67) * End caps are added by default	Min. - 1.97" Max. run - 42.6' Cut Inc. - 1.97"

Example: LN0612XSV-30-293-FF-OW-IJ-3.28'

* Customizable—Contact Beamever representatives

* Do not install in an environment that is permanently flooded with water or high in humidity, as damage to the neon will occur.

Feed Entry Options

For injected end cap (IP67), factory made only

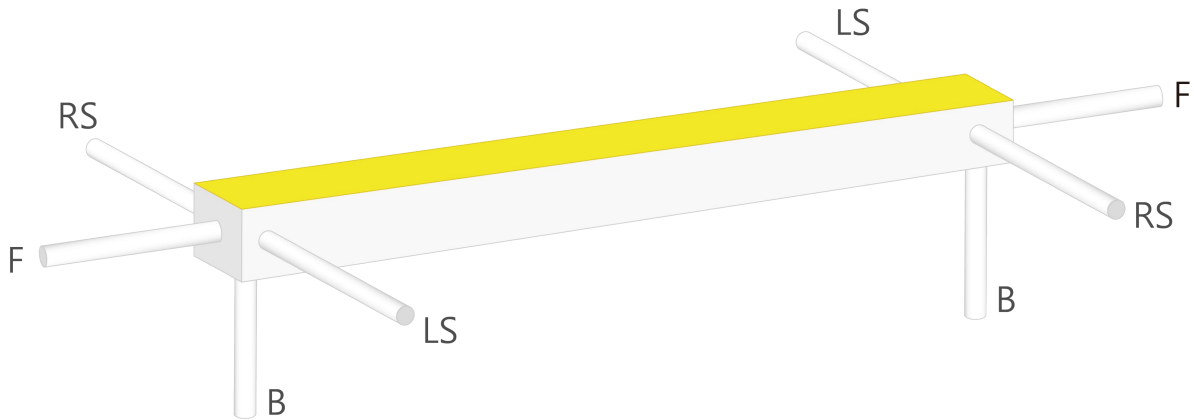

For silicone end cap (IP67)

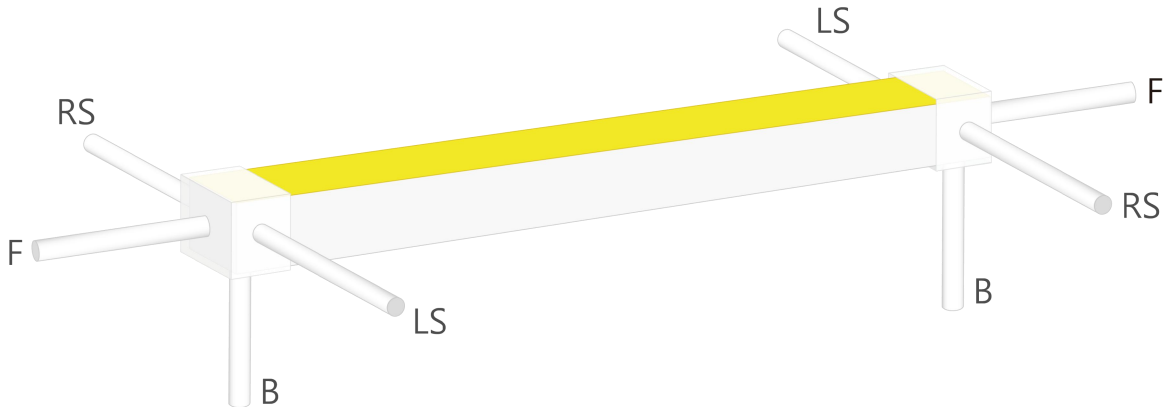

LINIO NEON 0612X SV

Outdoor · Horizontal Bending · Field cuttable



Mounting Options

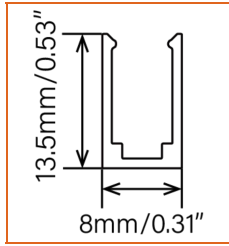
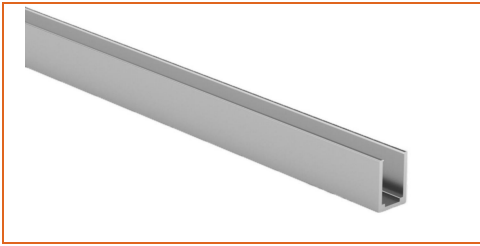

* Standard length is 3.28'/pcs.

Name	Straight aluminum channel
Code	LN0612-SC
Material	Aluminum
Mounting style	Surface mounted
Length	3.28' (1m)
Width	0.31" (8mm)
Height	0.53" (13.5mm)
Internal width	/

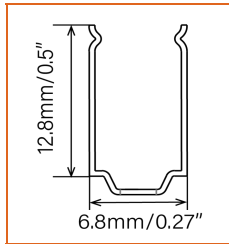

* Recommend use 1 mounting clip for 1' of neon.

Name	Mounting clip
Code	LN0612-CL
Material	Stainless Steel
Mounting style	Surface mounted
Length	0.59" (15mm)
Width	0.27" (6.8mm)
Height	0.5" (12.8mm)
Internal Width	/

Driver Options

Code	Max Load	Input	Output	Dimmable	Class 2	Environment	Size (L*W*H)
Non Dimmable							
KV-24030-ASW	30W	100-277VAC	24V	No	Yes	Dry/damp	6.10*2.12*0.78 inch
KV-24060-ASW	60W	100-277VAC	24V	No	Yes	Dry/damp	7.00*2.40*0.94 inch
KV-24096-ASW	96W	100-277VAC	24V	No	Yes	Dry/damp/wet	9.05*2.75*1.69 inch
KV-24150-ASW	150W	100-277VAC	24V	No	No	Dry/damp/wet	10.07*3.07*1.85 inch
KV-24200-ASW	200W	100-277VAC	24V	No	No	Dry/damp/wet	10.07*3.07*1.85 inch
KV-24300-ASW	300W	100-277VAC	24V	No	No	Dry/damp/wet	10.86*3.07*1.85 inch
Phase cut /Triac Dimmable							
KVF-24030-TDW	30W	100-277VAC	24V	Yes	Yes	Dry/damp	6.10*2.12*0.78 inch
KVF-24060-TDW	60W	100-277VAC	24V	Yes	Yes	Dry/damp	7*2.4*0.94 inch
KVF-24096-TDW	96W	100-277VAC	24V	Yes	Yes	Dry/damp/wet	9.05*2.75*1.69 inch
KVF-24150-TDW	150W	100-277VAC	24V	Yes	No	Dry/damp/wet	10*3.07*1.85 inch
KVF-24200-TDW	200W	100-277VAC	24V	Yes	No	Dry/damp/wet	10*3.07*1.85 inch
KVF-24300-TDW	300W	100-277VAC	24V	Yes	No	Dry/damp/wet	10.87*3.07*1.85 inch
4 in 1 Dimmable (0-10V/1-10V/Potentiometer/10V PWM)							
KVD-24030-DIM	30W	100-277VAC	24V	Yes	Yes	Dry/damp	6.10*2.12*0.78 inch
KVD-24060-DIM	60W	100-277VAC	24V	Yes	Yes	Dry/damp	7.01*2.40*0.94 inch
KVD-24096-DIM	96W	100-277VAC	24V	Yes	Yes	Dry/damp/wet	9.05*2.75*1.69 inch
KVD-24150-DIM	150W	100-277VAC	24V	Yes	No	Dry/damp/wet	10.08*3.07*1.85 inch
KVD-24200-DIM	200W	100-277VAC	24V	Yes	No	Dry/damp/wet	13.38*11.02*7.28 inch
KVD-24300-DIM	300W	100-277VAC	24V	Yes	No	Dry/damp/wet	10.87*3.07*1.89 inch

LINIO NEON 0612X SV

Outdoor · Horizontal Bending · Field cuttable



5 in 1 Dimmable (Triac/0-10V/1-10V/Potentiometer/10V PWM)

KVG-24030-DW	30W	100-277VAC	24V	Yes	Yes	Dry/damp	6.1*2.13*0.79 inch
KVG-24060-DW	60W	100-277VAC	24V	Yes	Yes	Dry/damp	7.01*2.41*0.94 inch
KVG-24096-DW	96W	100-277VAC	24V	Yes	Yes	Dry/damp/wet	9.06*2.76*1.69 inch
KVG-24150-DW	150W	100-277VAC	24V	Yes	No	Dry/damp/wet	10.08*3.07*1.85 inch
KVG-24200-DW	200W	100-277VAC	24V	Yes	No	Dry/damp/wet	10.08*3.07*1.85 inch
KVG-24300-DW	300W	100-277VAC	24V	Yes	No	Dry/damp/wet	10.87*3.07*1.89 inch

* Please refer to the spec sheet of each power supply for more detailed information

* KVF, KVD, KVG series are available in junction box enclosure, you can select it by adding "J" at the end of the driver code, e.g. KVF-24030-TDwj, and refer to its standalone spec sheet on our website.

Accessories Options (Optional, purchase for extra)



Name Silicone closed end cap

Code LN0612-SEC-C

Closed silicone end cap

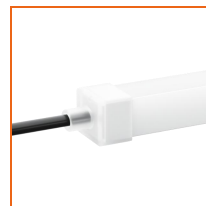

Name Silicone front end cap

Code LN0612-SEC-F-2P

Silicone end cap front entry with 11.81" black cable, 2 pin



Name Silicone side end cap

Code LN0612-SEC-S-2P

Silicone end cap side entry with 11.81" black cable, 2 pin



Name Silicone bottom end cap

Code LN0612-SEC-B-2P

Silicone end cap bottom entry with 11.81" black cable, 2 pin



Name Male and female connectors

Code MFC-2P-67-W

Male and female connectors with 11.81" white cable, 2 pin



Name Male and female connectors

Code MFC-2P-67-B

Male and female connectors with 11.81" black cable, 2 pin



Name Extension connectors

Code ETC-2P-67-1M

Extension male and female connectors with 1m (3.28ft) white cable, 2 pin



Name Extension connectors

Code ETC-2P-67-5M

Extension male and female connectors with 5m (16.4ft) white cable, 2 pin

LINIO NEON 0612X SV

Outdoor · Horizontal Bending · Field cuttable



Wiring Diagram

Non Dimmable

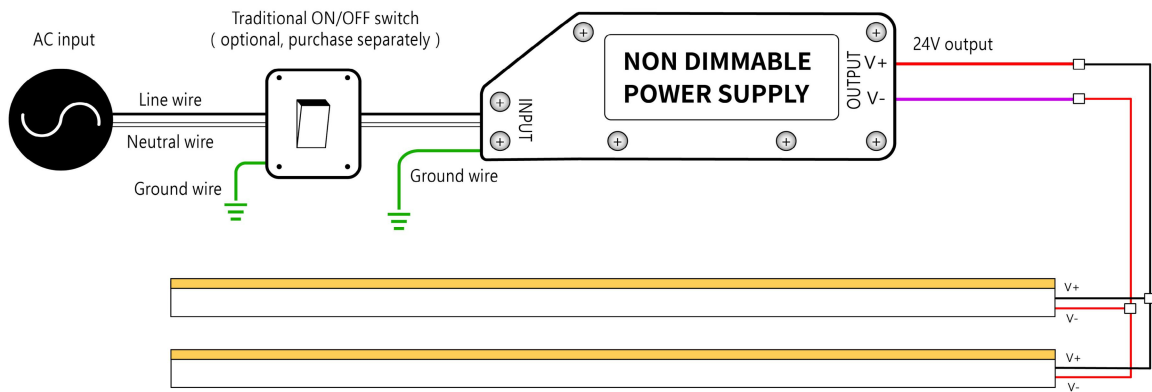

Dimmable

