

BELA TAPE RGBWW

Indoor · RGBWW

Beamever

Features

- Field cuttable & joinable
- Operates at safe and energy-efficient voltage of DC24V
- Slim and elegant, ideal for indoor applications
- 3M tape on the back makes it easy to install
- RGBWW allows for versatile lighting effects
- 5 years warranty



Fixture type	
Project name	
Project phase	
Date	



Dimension & Bending



Physical

PCB Width	0.47" (12mm)
LED Pitch	0.66" (16.7mm)
Cutting Interval	3.94" (100mm)
LED Brand	Sanan
LED Size	5050 (5 in 1)
LED Quantity	18 LEDs/ft (60 LEDs/m)
Housing Material	N/A
Housing Technique	N/A
Adhesive Type	Yellow 3M tape
Feed Entry	Front
Feed Length	Standard length 3.28'
Storage Temperature	-25~60°C (-13~140°F)
Ambient Temperature	-20~45°C (-4~113°F)
Max Production Length	164ft (50m)

Performance & Electrical

Voltage	24VDC (23.5Vmin, 24.5Vmax)
Beam Angle	120°
MacAdam	3 steps
Efficacy (lm/W)	60lm/W
CRI	Ra90
Lumen Maintenance	> 30,000 hours
IP Rating	IP20
Resistance	UV, solvent, saltwater, flame
Dimming	Triac, ELV, PWM, 0-10V, DMX
Control Protocol	N/A
Warranty	5 years

Certification & Safety

Certifications	UL
Environment	Dry location

Lumen/ft	5.85W
■ R	38
■ G	101
■ B	23
■ W27	92
■ W65	104
■ RGBWW2765	351
Max. Run Length (ft)	16.4

BELA TAPE RGBWW

Indoor · RGBWW



Order Code

Series	Temp./Color	Power	Connector Wire	IP Rating	Length (ft)
BELA	RGBWW2765	585=5.85W	OW=Open wire 3.28' MFC=Male & female connector 0.98'	20=IP20	Min. - 3.94' Max. - 98.4' Cut Inc. - 3.94'

Example: BELA-RGBWW2765-585-OW-20-11'

* Customizable—Contact Beamever representatives

Mounting Options

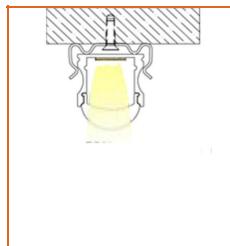
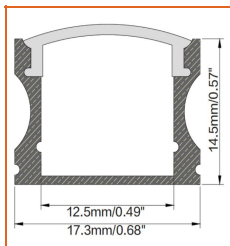
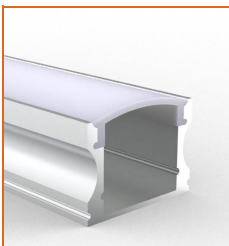

* Standard length is 3.28'/pcs.

Name	Straight aluminum channel
Code	BE1202
Material	Aluminum
Mounting style	Surface mounted
Length	3.28' (1m)
Width	0.68" (17.3mm)
Height	0.57" (14.5mm)
Internal width	0.49" (12.5mm)

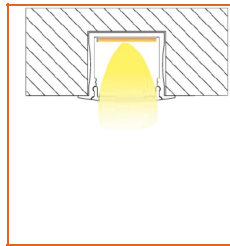
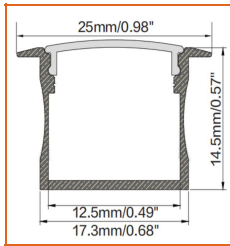
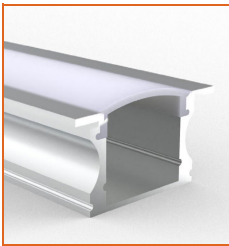

* Standard length is 3.28'/pcs.

Name	Straight aluminum channel
Code	BE1201
Material	Aluminum
Mounting style	Recessed mounted
Length	3.28' (1m)
Width	0.68" (17.3mm)
Height	0.57" (14.5mm)
Internal width	0.49" (12.5mm)

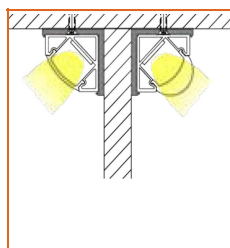
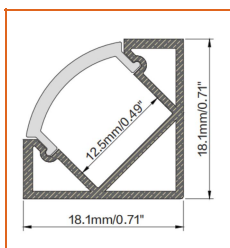
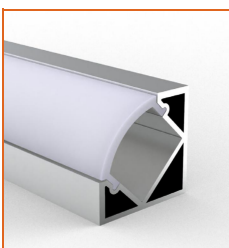

* Standard length is 3.28'/pcs.

Name	Straight aluminum channel
Code	BE1203
Material	Aluminum
Mounting style	Angled mounted
Length	3.28' (1m)
Width	0.71" (18.1mm)
Height	0.71" (18.1mm)
Internal width	0.49" (12.5mm)

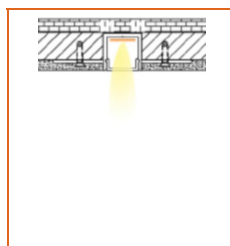
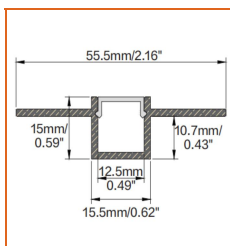
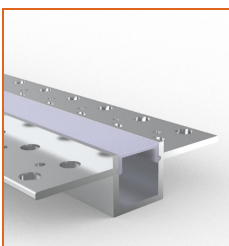

* Standard length is 3.28'/pcs.

Name	Straight aluminum channel
Code	BE5615
Material	Aluminum
Mounting style	Mud-in
Length	3.28' (1m)
Width	0.62" (15.5mm)
Height	0.59" (15mm)
Internal width	0.49" (12.5mm)

* For more options, please refer to "Beamever Profile Spec Sheet"

BELA TAPE RGBWW

Indoor · RGBWW



Driver Options

Code	Max Load	Input	Output	Dimmable	Class 2	Environment	Size (L*W*H)
Non Dimmable							
KV-24030-ASW	30W	100-277VAC	24V	No	Yes	Dry/damp	6.10*2.12*0.78 inch
KV-24060-ASW	60W	100-277VAC	24V	No	Yes	Dry/damp	7.00*2.40*0.94 inch
KV-24096-ASW	96W	100-277VAC	24V	No	Yes	Dry/damp/wet	9.05*2.75*1.69 inch
KV-24150-ASW	150W	100-277VAC	24V	No	No	Dry/damp/wet	10.07*3.07*1.85 inch
KV-24200-ASW	200W	100-277VAC	24V	No	No	Dry/damp/wet	10.07*3.07*1.85 inch
KV-24300-ASW	300W	100-277VAC	24V	No	No	Dry/damp/wet	10.86*3.07*1.85 inch
DMX512 Dimmable							
KVX-24096-4C-A	96W	100-277VAC	24V	Yes	Yes	Dry/damp/wet	9.05*3.07*0.98 inch
KVX-24150-4C-A	150W	100-277VAC	24V	Yes	No	Dry/damp/wet	10.9*3.07*0.98 inch
KVX-24200-4C-A	200W	100-277VAC	24V	Yes	No	Dry/damp/wet	10.9*3.07*0.98 inch
KVX-24300-4C-A	300W	100-277VAC	24V	Yes	No	Dry/damp/wet	11.85*3.07*0.98 inch

* Please refer to the spec sheet of each power supply for more detailed information

DMX Decoder Options

Code	Description
LT-904	4 channels output, up to 576W output power
LT-916	16 channels output, up to 1152W output power
LT-932	32 channels output, up to 2304W output power

* Please refer to the spec sheet of each decoder for more detailed information

Controller Options

Code	Description
DINA-DR micro	DMX 60 channels, DMX Stand Alone controller with 10 scenes, USB connectivity for programming
SLESA-U9	DMX 256 channels, USB connection, stand alone mode with 1 area and 20 scenes
STICK-GA2	DMX 512 channels, ready to use (pre-loaded with 8 scenes and 170 RGB fixtures)
STICK-CW4	DMX 1024 channels, up to 36 scenes stored and directly recalled via 6 touch sensitive buttons

* Please refer to the spec sheet of each controller for more detailed information

Accessories Options (Optional)



Name Strip to strip connector

Code BELA20-ST5-6P-12

Connector for 0.47" (12mm) strip to strip connection, IP20, 6 pin



Name Strip to cable connector

Code BELA20-STC-6P-12

Connector for 0.47" (12mm) strip to cable connection, IP20, 6 pin



Name VHB 3M adhesive tape

Code VHB

VHB 3M adhesive back tape, stronger stickiness.



Name Male & female DC connector

Code MFC-DC-44

Male and female DC connector with 11.81" cable, IP44

Wiring Diagram

Nicolaudie + DMX Control System

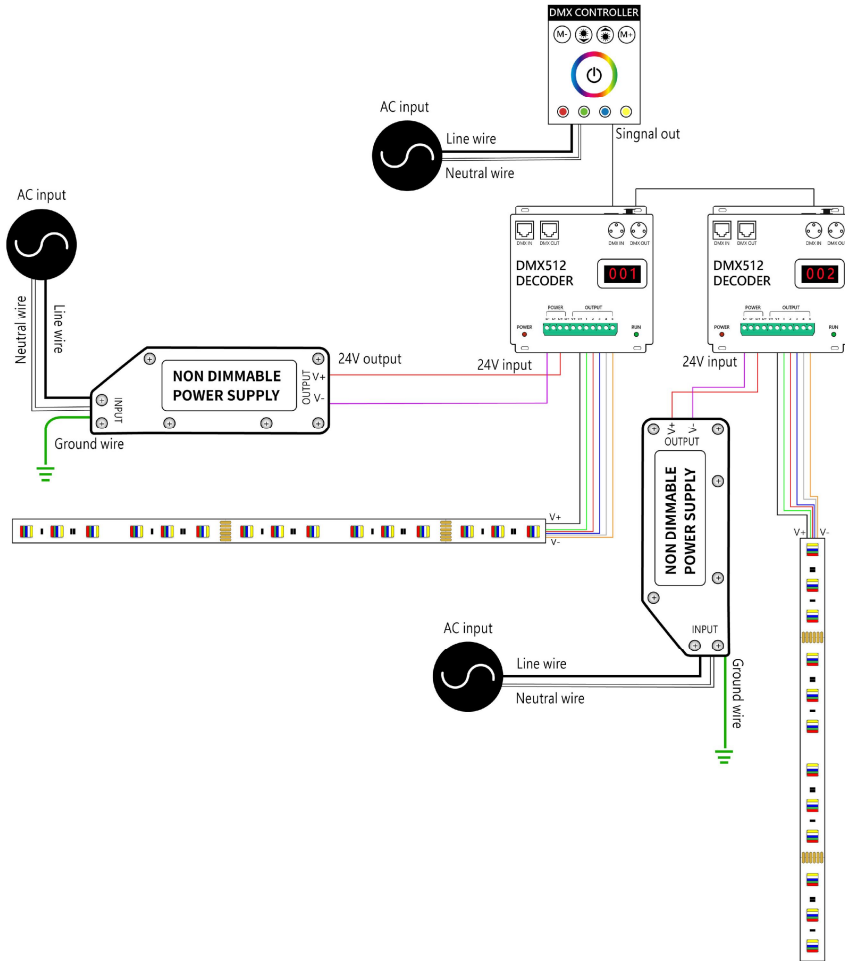

Nicolaudie + DMX Driver System

